

Adapter plate - HC-D 15-ADP/1 DSUB 15 - 1775253

Please be informed that the data shown in this PDF Document is generated from our Online Catalog. Please find the complete data in the user's documentation. Our General Terms of Use for Downloads are valid (<http://download.phoenixcontact.com>)

D-SUB adapter plate, for one D-SUB connector, no. of positions 15, housing series HC-D 15...



Key commercial data

Packing unit	1 pc
Minimum order quantity	2 pc
GTIN	 4 017918 037987
Weight per Piece (excluding packing)	9.4 GRM
Custom tariff number	85389099
Country of origin	Germany

Technical data

Dimensions

Length	57 mm
Height	23 mm
Hole diameter	3.2 mm
Drill hole distance, horizontal	49.5 mm
Drill hole distance, vertical	16 mm

General

Material	PA
Inflammability class according to UL 94	HB
Color	gray
Number of positions	15
Design	D15

Adapter plate - HC-D 15-ADP/1 DSUB 15 - 1775253

Classifications

eCl@ss

eCl@ss 4.0	27140816
eCl@ss 4.1	27140816
eCl@ss 5.0	27143424
eCl@ss 5.1	27143424
eCl@ss 6.0	27143424
eCl@ss 7.0	27440209
eCl@ss 8.0	27440209

ETIM

ETIM 3.0	EC002309
ETIM 4.0	EC002309
ETIM 5.0	EC002309

UNSPSC

UNSPSC 6.01	30211808
UNSPSC 7.0901	39121408
UNSPSC 11	39121408
UNSPSC 12.01	39121408
UNSPSC 13.2	39121408

Approvals

Approvals

Approvals

GOST

Ex Approvals

Approvals submitted

Approval details

GOST 
--

Adapter plate - HC-D 15-ADP/1 DSUB 15 - 1775253

Drawings

Dimensioned drawing

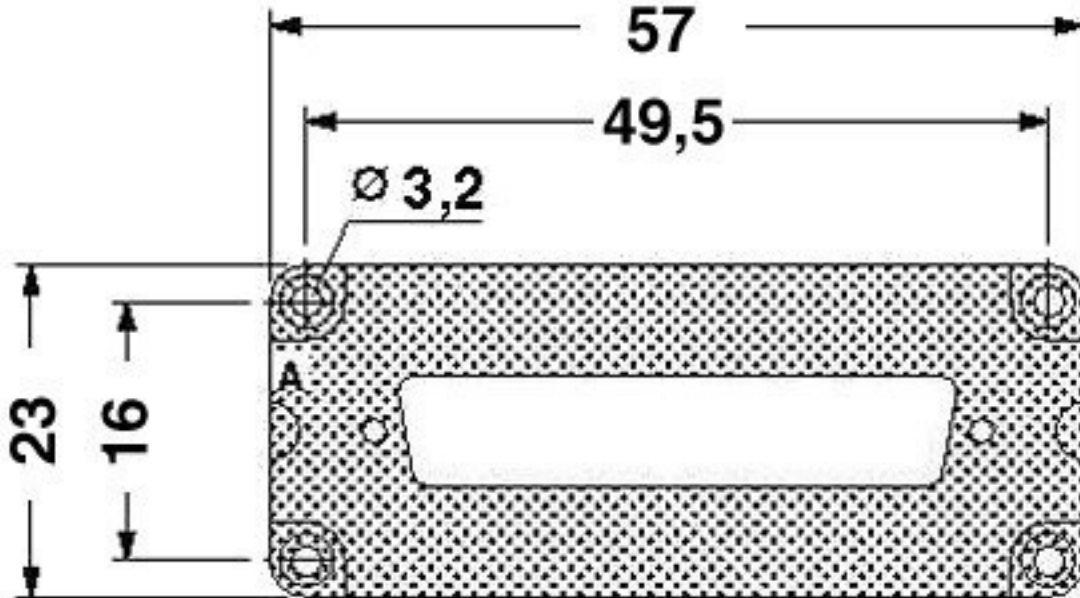

Dimensioned drawing

