



N-Tron[®] Series

308FX2, 309FX, 316TX, 317FX

Industrial Ethernet Switches

User Guide | December 2015

COPYRIGHT

Copyright, © 2015 Red Lion Controls, Inc.

20 Willow Springs Circle

York, PA 17406

All rights reserved. Red Lion, the Red Lion logo and N-Tron are registered trademarks of Red Lion Controls, Inc. All other company and product names are trademarks of their respective owners.

CONTACT INFORMATION:

AMERICAS

York, PA: +1 (717) 767-6511

Mobile, AL: +1 (251) 342-2164

Ballston Lake, NY: +1 (518) 877-5173

Hours: 8am-6pm Eastern Standard Time
(UTC/GMT -5 hours)

ASIA-PACIFIC

Shanghai, P.R. China: +86 21-6113-3688 x767

Hours: 10am-6pm China Standard Time
(UTC/GMT +8 hours)

EUROPE

The Netherlands: +31 33-4723-225

Hours: 9am-6pm Central European Time
(UTC/GMT +1 hour)

Website: www.redlion.net

Email: customer.service@redlion.net

Preface	iii
Disclaimer	iii
Compliance Information	iii
Part 15 of the Federal Communications Commission (FCC) - A Rules: Interference	iii
Industry Canada	iii
Environmental Impact Statement	iv
Toxic Emissions	iv
Trademark Acknowledgments	iv
Applicable 300 TX/FX Models Industrial Ethernet Switches	v
Release Notes and Document Updates	vi
Publication History	vi
Related Documents	vi
Document Comments	vi
Additional Product Information	vi
Warnings and Cautions / Avertissements et mises en garde	vi
General Safety Cautions and Warnings / Précautions et avertissements de sécurité générale	vi
Electrical Safety Warnings / Avertissements de sécurité électrique	vii
Environmental Safety Cautions and Warnings / Sécurité environnementale mises en garde et avertissements	viii
UL/cUL Hazardous Location Warning / UL/cUL Avertissement d'emplacement dangereux	viii
Laser Safety Warning / Consignes de sécurité relatives au laser	ix
Section 1 Introduction and Specifications	1-1
Introduction	1-1
308FX2 and 308FXE2	1-1
316TX	1-1
309FX and 317FX	1-1
309FXE and 317FXE	1-1
Key Features	1-2
Key Specifications	1-3
Regulatory Approvals	1-7
Safety	1-7
EMI	1-7
EMS	1-7
Conducted Low Frequency: IEC60533	1-7
Shock: IEEE 1613 (250 mm)	1-7
Vibration	1-7
Cold: IEC60068-2-1	1-7
Dry Heat: IEC60068-2-2	1-7
Damp Heat: IEC60068-2-30 (Test D _b)	1-7
Certifications	1-8

Section 2 Installation	2-9
Introduction	2-9
Unpacking	2-9
Inspection	2-9
Installing/Mounting	2-9
ATEX Installation Requirements	2-10
DIN-Rail Mounting	2-11
Panel and Rack Mounting	2-11
Connections	2-12
Power Connection (Side View)	2-12
300 TX/FX Models Grounding Techniques	2-13
RJ45 Connector Crimp Specifications	2-14
Connecting the Unit	2-14
Serial Interface	2-15
Serial Cable	2-15
Hyper Terminal	2-15
Section 3 Operation and Maintenance	3-17
Introduction	3-17
300 TX/FX Models Ports and Indicators	3-17
300 TX/FX Models LED's and Operating Modes	3-18
Software Configuration	3-18
Command Line Interpreter (CLI)	3-18
Logging In (password protection)	3-19
CLI Navigation	3-20
CLI Menu Tree	3-20
CLI Menus and Commands	3-20
Home Menu	3-21
Home Menu Info Command	3-21
System Menu	3-21
N-View™ Menu	3-22
System Info Menu	3-23
Restore (Restoring Defaults)	3-23
Switch Menu	3-23
Ports Commands	3-24
Filters Commands	3-26
Trouble Shooting	3-26
Cleaning	3-27
Maintenance	3-27
N-Tron® Series 300 TX/FX Models Limited Warranty	3-27

Preface

Disclaimer

Portions of this document are intended solely as an outline of methodologies to be followed during the maintenance and operation of N-Tron® series 300 TX/FX equipment. It is not intended as a step-by-step guide or a complete set of all procedures necessary and sufficient to complete all operations.

While every effort has been made to ensure that this document is complete and accurate at the time of release, the information that it contains is subject to change. Red Lion Controls is not responsible for any additions to or alterations of the original document. Industrial networks vary widely in their configurations, topologies, and traffic conditions. This document is intended as a general guide only. It has not been tested for all possible applications, and it may not be complete or accurate for some situations.

Users of this document are urged to heed warnings and cautions summarized at the front of the document, such as electrical hazard warnings.

Compliance Information

It is recommended that the owner of this equipment determine and ensure conformance with any specific and applicable local regulations.

Part 15 of the Federal Communications Commission (FCC) - A Rules: Interference

Every effort has been made to ensure that this equipment is designed to comply with the limits for a Class A digital device, as described in the FCC Rules.

This product complies with Part 15 of the FCC-A Rules.

Operation is subject to the following conditions:

1. This device may not cause harmful Interference
2. This device must accept any interference received, including interference that may cause undesired operation. This equipment has been tested and found to comply with the limits for a Class A digital device, pursuant to Part 15 of the FCC Rules. These limits are designed to provide reasonable protection against harmful interference in a residential installation. This equipment generates, uses, and can radiate radio frequency energy and, if not installed and used in accordance with the instructions, may cause harmful interference to radio communications. Operation of this device in a residential area is likely to cause harmful interference in which case the user will be required to correct the interference at their own expense.

Industry Canada

This Class A digital apparatus meets all requirements of the Canadian Interference Causing Equipment Regulations. Operation is subject to the following two conditions; (1) this device may not cause harmful interference, and (2) this device must accept any interference received, including interference that may cause undesired operation.

Cet appareillage numérique de la classe A répond à toutes les exigences de l'interférence canadienne causant des règlements d'équipement. L'opération est sujette aux deux conditions suivantes: (1) ce dispositif peut ne pas causer l'interférence nocive, et (2) ce dispositif doit accepter n'importe quelle interférence reçue, y compris l'interférence qui peut causer l'opération peu désirée.



Environmental Impact Statement

Red Lion equipment contains no hazardous materials as defined by the United States Environmental Protection Agency (USEPA). Red Lion recommends that all failed product be returned to Red Lion for failure analysis and proper disposal.

Toxic Emissions

Red Lion equipment releases no toxic emissions.

Trademark Acknowledgments

Ethernet is a registered trademark of Xerox Corporation.



Applicable 300 TX/FX Industrial Ethernet Switches

This User and Installation Guide applies to the 300 TX/FX models presented in [Table 1](#).

Table 1. Ordering Guide

Part Number	Description
308FX2-N-XX	Eight port - six 10/100BaseTX RJ-45 ports and two 100BaseFX multimode fiber ports with ST or SC connectors
308FXE2-N-XX-YY	Eight port - six 10/100BaseTX RJ-45 ports and two 100BaseFX singlemode 15km, 40km or 80km fiber ports with ST or SC connectors
309FX-N-XX	Nine port - eight 10/100BaseTX RJ-45 ports and one 100BaseFX multimode fiber port with ST or SC connectors
309FXE-N-XX-YY	Nine port - eight 10/100BaseTX RJ-45 ports and one 100BaseFX singlemode 15km, 40km or 80km fiber port with ST or SC connectors
316TX-N	16 ports- 16 10/100BaseTX RJ-45 ports
317FX-N-XX	17 port - 16 10/100BaseTX RJ-45 ports and one 100BaseFX multimode port with ST or SC connectors
317FXE-N-XX-YY	17 port - 16 10/100BaseTX RJ-45 ports and one 100BaseFX singlemode 15km, 40km or 80km fiber port with ST or SC connectors

Where:

N = N-View Option

E = Singlemode

XX = ST for ST style fiber connector, SC for SC style fiber connector

YY = Segment length

15 for 15km maximum fiber segment length

40 for 40km maximum fiber segment length

80 for 80km maximum fiber segment length

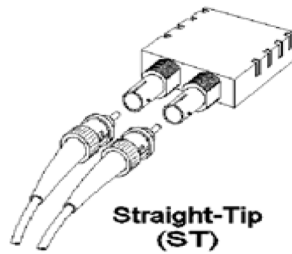

Straight-Tip (ST)

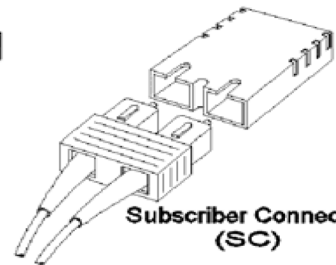

Subscriber Connector (SC)



308FX2



309FX



316TX



317FX

Release Notes and Document Updates

The hard copy and electronic media versions of this document are revised only at major releases and therefore, may not always contain the latest product information. As needed, Documentation Notes and/or Product Bulletins will be provided between major releases to describe any new information or document changes.

The latest online version of this document and all product updates can be accessed through the Red Lion web site at <http://www.redlion.net>

Publication History

The following information lists the release history of this document.

Issue/Revision	Release Date	Content Description
Revised 2013-06-21	June 2013	Document Updates
Revised 2015-11-09	November 2015	Added safety information and reformatted document.

Related Documents

Visit the Technical Resources page on the Red Lion website at the following link to view available documents related to this product.

<http://www.redlion.net/documentation/red-lion-documentation>

Document Comments

Red Lion appreciates all comments that will help us to improve our documentation quality. The user can submit comments through the Red Lion Customer Service. Simply email us at customer.service@redlion.net.

Additional Product Information

Additional product information can be obtained by contacting the local sales representative or Red Lion through the contact numbers and/or e-mail addresses listed on the inside of the front cover.

Warnings and Cautions / Avertissements et mises en garde

Warnings apply to situations where personal injury or death may result.





Mises en garde s'appliquent aux situations où des blessures corporelles ou la mort peuvent en résulter.

Cautions apply to where reduced function or damage to equipment may result.



Avertissements s'appliquent à où fonction réduite ou d'endommagement de l'équipement peut entraîner.

General Safety Cautions and Warnings / Précautions et avertissements de sécurité générale

	<p>CAUTION: Do not perform any services on the unit unless qualified to do so. Do not substitute unauthorized parts or make unauthorized modifications to the unit.</p> <p>ATTENTION: Ne pas effectuer de services sur l'appareil s'il n'est pas qualifié pour le faire. Ne pas substituer pièces non autorisées ou de modifications non autorisées de l'appareil.</p>
---	--

	<p>WARNING - Do not operate the unit with the top cover removed, as this could create a shock or fire hazard.</p> <p>AVERTISSEMENT - Ne pas faire fonctionner l'unité avec le couvercle retiré, ceci pourrait créer une décharge électrique ou un incendie.</p>
	<p>CAUTION: Do not block any air vents on the unit.</p> <p>ATTENTION: N'obstruez pas les fentes d'aération de l'unité.</p>
	<p>CAUTION: Do not operate the equipment in a manner not specified by this manual.</p> <p>ATTENTION: Ne pas faire fonctionner l'équipement d'une manière non spécifiée par ce manuel.</p>
	<p>CAUTION: If the equipment is used in a manner not specified by Red Lion, the protection provided by the equipment may be impaired.</p> <p>ATTENTION: Si l'équipement est utilisé d'une façon non spécifiée par Red Lion, la protection fournie par l'équipement peut être compromise.</p>

Electrical Safety Warnings / Avertissements de sécurité électrique

	<p>WARNING: Do not work on equipment or cables during periods of lightning activity.</p> <p>AVERTISSEMENT: Ne pas travailler sur le matériel ou les câbles pendant les périodes d'activité de la foudre.</p>
	<p>WARNING: Properly ground the unit before connecting anything else to the unit. Units not properly grounded may result in a safety risk and could be hazardous and may void the warranty. See the grounding technique section of this Hardware Guide for proper ways to ground the unit.</p> <p>AVERTISSEMENT: Correctement à la terre de l'unité avant tout raccordement à l'unité. Unités pas correctement mise à la terre peut entraîner un risque de sécurité et pourraient être dangereux et peut annuler la garantie. Voir la section technique de mise à la terre de ce mode d'emploi des moyens appropriés à la masse de l'appareil.</p>
	<p>WARNING: Disconnect the power cable before removing the enclosure top.</p> <p>AVERTISSEMENT: Débranchez le câble d'alimentation avant de retirer le boîtier supérieur.</p>



WARNING: Do not operate the unit with the top cover removed.
AVERTISSEMENT : Ne pas faire fonctionner l'unité avec le capot retiré.



CAUTION: Observe proper DC Voltage polarity when installing power input cables. Reversing voltage polarity can cause permanent damage to the unit and voids the warranty.
ATTENTION: Respecter la polarité correcte de tension DC lors de l'installation des câbles d'alimentation d'entrée. Inversion de polarité de tension peut causer des dommages permanents à l'appareil et annule la garantie.

Environmental Safety Cautions and Warnings / Sécurité environnementale mises en garde et avertissements



WARNING: Disconnect the power and allow to cool 5 minutes before touching.
AVERTISSEMENT: Déconnectez le câble d'alimentation et laissez refroidir 5 minutes avant de la toucher.



WARNING: Do not operate the equipment in the presence of flammable gases or fumes. Operating electrical equipment in such an environment constitutes a definite safety hazard.
AVERTISSEMENT : Ne pas utiliser le matériel en présence de gaz ou de vapeurs inflammables. L'utilisation de matériel électrique dans un tel environnement constitue un danger certain.

UL/cUL Hazardous Location Warning / UL/cUL Avertissement d'emplacement dangereux



WARNING – Explosion Hazard – Do not connect or disconnect any connections while circuit is live unless area is known to be non-hazardous.
AVERTISSEMENT - Risque d'explosion - Ne pas brancher ou débrancher les connexions lorsque le circuit est sous tension sauf si la zone est connue pour être non dangereux.



WARNING: Install only in accordance with Local and National Codes of authorities having jurisdiction.
AVERTISSEMENT: Installer uniquement, conformément aux codes locaux et nationaux des autorités ayant compétence.



CAUTION: Power must be supplied by an isolating source, and a 3.3A max rated UL recognized fuse must be installed immediately before the unit.
ATTENTION: celui-ci doit être alimenté par une source à isolation et un 3.3A nominale max. fusible homologué UL doit être installé immédiatement avant l'unité.



CAUTION: Class I, Division 2 installations require that all devices connected to this product must be UL listed for the area in which it is installed.

ATTENTION: Classe I, division 2 installations nécessitent que tous les périphériques connectés à ce produit doit être homologué UL pour la zone dans laquelle il est installé.



CAUTION: Only UL listed wiring with temperature ratings greater than 90°C permitted for Class I, Division 2 installations operating at temperatures up to 70°C ambient.

ATTENTION: uniquement listés UL câblage avec cotes de température supérieure à 90 °C Permis de classe I, division 2 équipements fonctionnant à des températures allant jusqu'à 70°C de température ambiante.



CAUTION: Limited Operating Voltage range of 12-30V for Class I, Division 2 installations.

ATTENTION: limiter la plage de tension de fonctionnement de 12-30 V pour la classe I, division 2 installations..



CAUTION: This equipment is suitable for use in Class I, Division 2, Groups A, B, C, and D or non-hazardous locations only.

ATTENTION: Cet équipement est adapté pour une utilisation dans la classe I, Division 2, Groupes A, B, C et D ou non dangereux endroits seulement.

Laser Safety Warning / Consignes de sécurité relatives au laser



CAUTION (FXE-40 and FXE-80 only): CLASS 1 LASER PRODUCT. Do not stare into the laser.

ATTENTION (FXE-40 et FXE-80 uniquement): PRODUIT LASER CLASSE 1. Ne pas regarder dans le laser.



Section 1 Introduction and Specifications

Introduction

The Red Lion N-Tron® series 308FX2/309FX/316TX/317FX Industrial Ethernet switches support high speed layer 2 switching between ports. The copper ports in this line are Category 5 compliant 10/100-BaseTX connections for high performance network design, and hub/repeater upgrades. These copper ports are capable of auto negotiating 10/100 Mb and half/full duplex communications, or the user can configure these parameters.

The 300 series provides Fast Ethernet connectivity from 8 to 17 ports. These unmanaged switches are available in copper and fiber port combinations for maximum deployment flexibility. They are also optionally available with N-View™ monitoring technology, which can be found in the Red Lion monitored family of products.

308FX2 and 308FXE2

The 308FX2 is an affordable 8 port switch that has 6 copper ports plus two additional multimode fiber optic up-link ports. The two fiber links are capable of 2 Kilometers of 100 Mb communications without the use of repeaters. The 308FXE2 is similar to the 308FX2, but is populated with singlemode extended range fiber optics.

316TX

The 316TX is an affordable 16 port copper port switch.

309FX and 317FX

The 309FX (317FX) is a 9 (17) port switch that has 8 (16) copper ports, plus an additional multimode fiber optic up-link port in the 309FX and in the 317FX. The fiber links are capable of 2 Kilometers of 100 Mb communications without the use of repeaters.

309FXE and 317FXE

The 309FXE (317FXE) is a 9 (17) port switch that is similar to the 309FX (317FX), but with extended range. The FXE versions utilize a singlemode fiber transceiver that is capable of 15-80 Kilometers of 100 Mb communications

All FX, FX2, FXE, and FXE2 models utilize the IEEE compliant SC or ST duplex connector for fiber optic communications. The 10/100Base-TX ports utilize the RJ45 shielded connector.

All N-Tron® series switches come housed in a steel ruggedized DIN-Rail enclosure, designed to withstand the most demanding industrial applications, and have been fully tested and certified at industrial environmental extremes. All units operate on 10-30VDC.



Key Features

- Full IEEE 802.3 & 100Base-FX Compliance
- Full IEEE 1613 Compliance (Communications Networking Devices in Electric Power Stations)
- American Bureau of Shipping (ABS) Type Approval (Maritime and Offshore Applications)
- Extended Environmental Specifications
- Support for Full/Half Duplex Operation
- LED Link/Activity Status Indication
- Autosensing Speed and Flow Control
- Up to 2.6 Gb/s Maximum Throughput
- Industry Standard 35mm DIN-Rail Mounted Enclosure
- Optional N-View™ Monitoring on -N units.

Key Specifications

Table 2. 308FX2/FXE2 Key Specifications

Switch Properties				
# of MAC Addresses	Aging Time	Latency Minimum	Backplane Speed	Switching Method
4,000	Programmable	2.2 μ s	2.6 Gb/s	Store & Forward
Physical				
Height	Width	Depth	Weight	DIN-Rail
5.9 in (15cm)	2.3 in (5.8cm)	3.8 in (9.7cm)	1.7 lbs (0.8kg)	35mm
Electrical				
Redundant Input Voltage	Input Current	Inrush Current	Input Ripple	
10-30 VDC	380mA max. @ 24VDC (max current 1.0 A)	8.5 Amp/0.2 ms @ 24VDC	Less than 100 mV	
Environmental				
Operating and Storage Temperature		Operating Humidity		Operating Altitude
-40°C to 85°C		10% to 95% (non condensing)		0 to 10,000 ft.
Shock and Vibration				
Shock	Vibration/Seismic		Note	
200g @ 10ms	50g, 5-200Hz, Triaxial		Unit must be bulkhead mounted to achieve these levels.	
Reliability				
MTBF (Mean Time Between Failure)		> Two (2) Million Hours		
Network		Media		
10BaseT		> Cat-3 Cable		
100BaseTX		> Cat-5 Cable		
100BaseFX				
Multimode:		50-62.5/125 μ m		
Singlemode:		7-10/125 μ m		
Connectors			Serial Port	
10/100BaseT	Six (6) RJ45 Copper Ports		Com Parameters	9600, n, 8, 1
100BaseFX	Two (2) SC or ST Duplex Ports			
Recommended Minimum Wiring Clearance				
Top	1" (2.54 cm)			
Front	4" (10.16 cm)			



Table 3. 309FX/FXE Key Specifications

Switch Properties				
# of MAC Addresses	Aging Time	Latency Minimum	Backplane Speed	Switching Method
4,000	Programmable	2.2 μ s	2.6 Gb/s	Store & Forward
Physical				
Height	Width	Depth	Weight	DIN-Rail
5.5 in (13.9cm)	2.3 in (5.8cm)	3.5 in (8.9cm)	1.6 lbs (0.8kg)	35mm
Electrical				
Redundant Input Voltage	Input Current	Inrush Current	Input Ripple	
10-30 VDC	260mA max. @ 24VDC (max current 0.5 A)	8.5 Amp/0.7 ms @ 24VDC	Less than 100 mV	
Environmental				
Operating & Storage Temperature		Operating Humidity		Operating Altitude
-40°C to 85°C		10% to 95% (non condensing)		0 to 10,000 ft.
Shock and Vibration				
Shock	Vibration Seismic		Note	
200g @ 10ms	50g, 5-200Hz, Triaxial		Unit must be bulkhead mounted to achieve these levels.	
Reliability				
MTBF (Mean Time Between Failure)		Two (2) Million Hours		
Network		Media		
10BaseT		> Cat-3 Cable		
100BaseTX		> Cat-5 Cable		
100BaseFX				
Multimode:		50-62.5/125 μ m		
Singlemode:		7-10/125 μ m		
Connectors			Serial Port	
10/100BaseT	Eight (8) RJ45 Copper Ports		Com Parameters	9600, n, 8, 1
100BaseFX	One (1) SC or ST Duplex Port			
Recommended Minimum Wiring Clearance				
Top	1" (2.54 cm)			
Front	4" (10.16 cm)			

Table 4. 316TX Key Specifications

Switch Properties				
# of MAC Addresses	Aging Time	Latency Minimum	Backplane Speed	Switching Method
4,000	Programmable	2.2 μ s	2.6 Gb/s	Store & Forward
Physical				
Height	Width	Depth	Weight	DIN-Rail
7.4 in (18.8cm)	2.3 in (5.8cm)	3.5 in (8.9cm)	1.9 lbs (0.9 kg)	35mm
Electrical				
Redundant Input Voltage	Input Current	Inrush Current	Input Ripple	
10-30 VDC	400mA max. @ 24VDC (max current 1.0 A)	7.0 Amp/0.8 ms @ 24VDC	Less than 100 mV	
Environmental				
Operating & Storage Temperature		Operating Humidity		Operating Altitude
-40°C to 85°C		10% to 95% (non condensing)		0 to 10,000 ft.
Shock and Vibration				
Shock	Vibration Seismic		Note	
200g @ 10ms	50g, 5-200Hz, Triaxial		Unit must be bulkhead mounted to achieve these levels.	
Reliability				
MTBF (Mean Time Between Failure)		Two (2) Million Hours		
Network		Media		
10BaseT		> Cat-3 Cable		
100BaseTX		> Cat-5 Cable		
Connectors			Serial Port	
10/100BaseT	Sixteen (16) RJ45 Copper Ports		Com Parameters	9600, n, 8, 1
Recommended Minimum Wiring Clearance				
Top	1" (2.54 cm)			
Front	2" (5.08 cm)			

Table 5. 317FX/FXE Key Specifications

Switch Properties				
# of MAC Addresses	Aging Time	Latency Minimum	Backplane Speed	Switching Method
4,000	Programmable	2.2 μ s	2.6 Gb/s	Store & Forward
Physical				
Height	Width	Depth	Weight	DIN-Rail
7.4 in (18.8cm)	2.3 in (5.8cm)	3.5 in (8.9cm)	1.9 lbs (0.9kg)	35mm
Electrical				
Redundant Input Voltage	Input Current	Inrush Current	Input Ripple	
10-30 VDC	440mA max. @ 24VDC (max current 1.0 A)	8.5 Amp/0.8 ms @ 24VDC	Less than 100 mV	
Environmental				
Operating & Storage Temperature		Operating Humidity		Operating Altitude
-40°C to 85°C		10% to 95% (non condensing)		0 to 10,000 ft.
Shock and Vibration				
Shock	Vibration Seismic			
200g @ 10ms	50g, 5-200Hz, Triaxial			
Reliability				
MTBF (Mean Time Between Failure)		Two (2) Million Hours		
Network		Media		
10BaseT		> Cat-3 Cable		
100BaseTX		> Cat-5 Cable		
100BaseFX				
Multimode:		50-62.5/125 μ m		
Singlemode:		7-10/125 μ m		
Connectors			Serial Port	
10/100BaseT	Sixteen (16) RJ45 Copper Ports		Com Parameters	9600, n, 8, 1
100BaseFX	One (1) SC or ST Duplex Fiber Port			
Recommended Minimum Wiring Clearance				
Top	1" (2.54 cm)			
Front	4" (10.16 cm)			

Table 6. Fiber Transceiver Characteristics FX/FXE Models

Fiber Length	2km*	15km**	40km**	80km**
TX Power Minimum	-19dBm	-15dBm	-5dBm	-5dBm
RX Sensitivity Maximum	-31dBm	-31dBm	-34dBm	-34dBm
Wavelength	1310nm	1310nm	1310nm	1550nm

* = Multimode **= Singlemode

Regulatory Approvals

Safety

Suitable for use in Class I, Division 2, Groups A, B, C and D Hazardous Locations, or Nonhazardous Locations only.

ATEX Zone 2, Category Ex nA IIC Gc DEMKO 03 ATEX 0316686U.

EMI

- EN61000-6-4, EN55011 - Class A
- FCC 47 CFR, Part 15, Subpart B - Class A

EMS

- EN61000-6-2
- EN61000-4-2 (ESD)
- EN61000-4-3 (RS)
- EN61000-4-4 (EFT)
- EN61000-4-5 (Surge)
- EN61000-4-6 (Conducted Disturbances)

Conducted Low Frequency: IEC60533

Shock: IEEE 1613 (250 mm)

Vibration

- IEEE 1613 (V.S.4 150mm/s)
- IEC60068-2-6 (Test F_c)

Cold: IEC60068-2-1

Dry Heat: IEC60068-2-2

Damp Heat: IEC60068-2-30 (Test D_b)



Certifications

GOST-R Certified



Section 2 Installation

Introduction

This sections contains the information and procedures necessary to unpack, inspect, install and connect the N-Tron® Series 300 TX/FX models.

Unpacking

Remove all the equipment from the packaging, and store the packaging in a safe place.

Inspection

Please ensure the shipping package contains the following items in undamaged condition:

1. 308FX2, 309FX, 316TX, or 317FX switch.
2. Product CD



If the package contents are damaged:



1. Contact your carrier.
2. File any damage claims with the carrier.

Installing/Mounting

Read the following warning before beginning the installation:

Lire l'avertissement suivant avant de commencer l'installation:

	<p>CAUTION (FXE-40 and FXE-80 only): CLASS 1 LASER PRODUCT. Do not stare into the laser (fiber optic connector) when installing or operating the equipment.</p> <p>ATTENTION (FXE-40 et FXE-80 uniquement): PRODUIT LASER CLASSE 1. PRODUIT LASER DE CLASSE 1. Ne pas regarder fixement le connecteur à fibre optique (laser) lors de l'installation ou le fonctionnement du matériel.</p>
	<p>WARNING: Do not work on equipment or cables during periods of lightning activity.</p> <p>AVERTISSEMENT: Ne pas travailler sur le matériel ou les câbles pendant les périodes d'activité de la foudre.</p>
	<p>WARNING – Explosion Hazard – Do not connect or disconnect any connections while circuit is live unless area is known to be non-hazardous.</p> <p>AVERTISSEMENT - Risque d'explosion - Ne pas brancher ou débrancher les connexions lorsque le circuit est sous tension sauf si la zone est connue pour être non dangereux.</p>

	<p>WARNING: Disconnect the power cable before removing the enclosure top. AVERTISSEMENT: Débranchez le câble d'alimentation avant de retirer le boîtier supérieur.</p>
	<p>WARNING: Do not operate the unit with the top cover removed. AVERTISSEMENT : Ne pas faire fonctionner l'unité avec le capot retiré.</p>

ATEX Installation Requirements

This section provides guidance for an installation to meet ATEX certification requirements.



II 3 G EX nA IIC Gc

1. The conductor size of the phase conductor must be in the range of 16-28AWG (0.08mm²-1.31mm²).
2. Field wiring must be suitable for a minimum of 110°C.
3. Ethernet Switches are intended for mounting in an ATEX-Certified IP54 enclosure in a pollution degree 2 environments as defined by IEC 60664-1.
4. Temperature testing of the Ethernet Switches was conducted on the switch itself in an 85°C air circulating oven and resulted in a Temperature Code of T4. However, end-product temperature testing shall be considered.
5. The end user shall provide bonding means as necessary. All bonding equipment (components) shall be evaluated according to EN 60079-15:2010 and covered by a component certificate for the actual use. When installing bonding components that will pass through an enclosure wall, they must have a minimum of IP54 rating equal to the enclosure. All electrical clearances must be maintained per the manufacturer's instructions of the bonding component or per EN 60079-15:2010.
6. Ethernet Switch requires protection against transients. The end-product shall provide a suitable form of protection that removes the risk of or limits transients to no more than 42V.
7. Products are evaluated to EN 60079-0:2012 and EN 60079-15:2010.

DIN-Rail Mounting - 308FX2 and 309FX

Install the unit on a standard 35mm DIN-Rail. Recess the 308FX2/309FX unit to allow at least 5" of horizontal clearance for fiber optic cable bend radius.

Vertical Mounting

1. To mount the unit vertically to the 35mm DIN-Rail, place the top edge of the bracket on the back of the unit against the DIN-Rail's top edge at an upward angle.
2. Rotate the unit downward and back against the DIN-Rail until it snaps into place.

Remove Vertical Mounted Unit

1. To remove the vertically mounted unit from 35mm DIN-Rail, carefully apply downward pressure on the unit.
2. Rotate the unit upward and away from the 35mm DIN-Rail and lift up for removal.

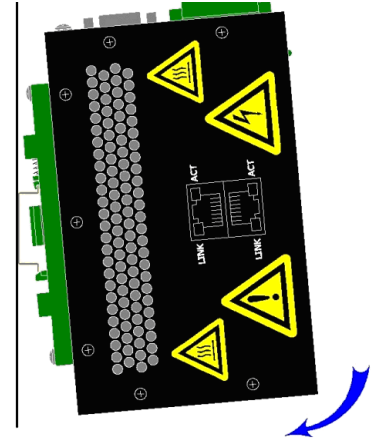

Horizontal Mounting

1. To mount the unit horizontally to the 35mm DIN-Rail, place the bottom edge of the bracket on the back of the unit against the DIN-Rail's bottom edge at a downward angle.
2. Rotate the unit upward and back against the DIN-Rail until it snaps into place.

Remove Horizontal Mounted Unit

1. To remove the horizontally mounted unit from 35mm DIN-Rail, carefully apply upward pressure on the unit.
2. Rotate the unit downward and away from the 35mm DIN-Rail and lower it for removal.

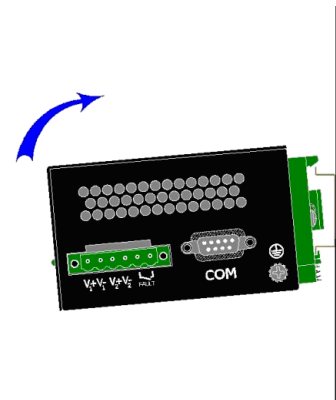

DIN-Rail Mounting - 316TX and 317FX

Install the unit on a standard 35mm DIN-Rail. Recess the 316TX unit to allow at least 3" of horizontal clearance for copper cable bend radius. Recess the 317FX unit to allow at least 5" of horizontal clearance for fiber cable bend radius. There should be at least 4" of clearance on both the top and bottom of the unit to allow proper ventilation.

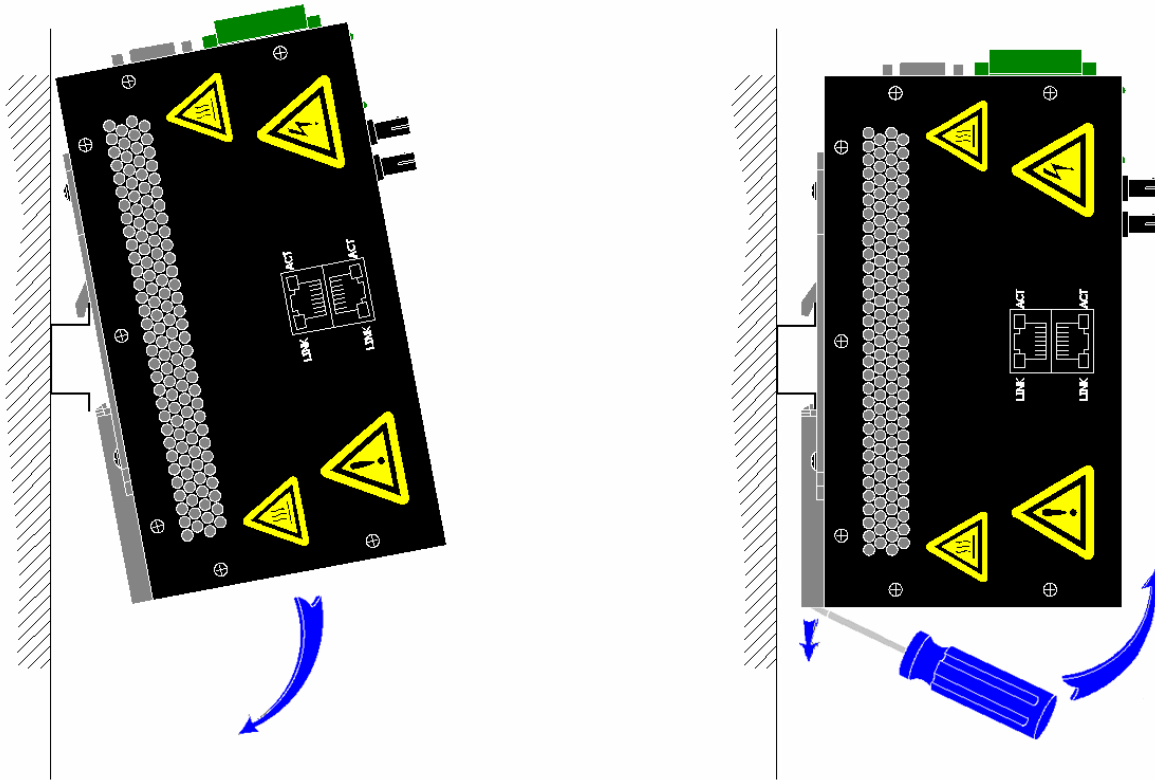

Horizontal Mounting

1. To mount the unit to the 35mm DIN-Rail, place the top edge of the bracket on the back of the unit against the DIN-Rail at an upward angle.
2. Lower the bottom of the unit until it snaps into place.

Note: When mounting the switch in the vertical position, you must orientate the power connector to the top as shown above for proper ventilation.

Optional Mounting

Most N-Tron® series products are designed to be mounted on industry standard 35mm DIN-Rail. However, DIN-Rail mounting may not be suitable for all applications. The Universal Rack Mount Kit (P/N: URMK), shown in the figure below, may be used to mount the 316TX/317FX unit to standard 19" racks as an option.



Connections

Power Connection (Side View)

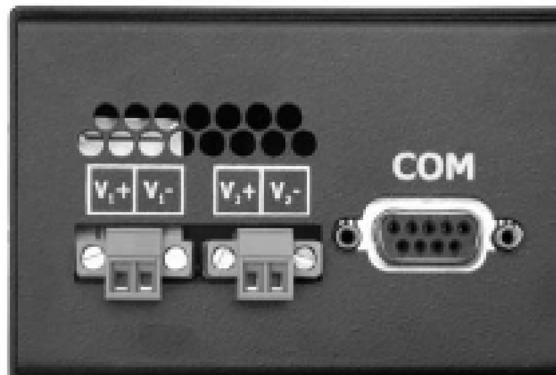

1. Unscrew & Remove the DC Voltage Input Plug from the side header.
2. Install the DC Power Cables into the Plug(s) (observing polarity on unit).
3. Plug the Voltage Input Plug(s) back into the side header.
4. Tightening torque for the terminal block power plug is **0.22 Nm/0.162 Pound Foot**.
5. All LED's will flash ON momentarily.
6. Verify the Power LED stays ON (GREEN).

Note: Only one plug must be connected to power for minimal operation. Either V1 or V2 can be connected to power for minimal operation. For redundant power operation, V1 and V2 plugs must be connected to separate DC Voltage sources. Use wire sizes of 16-28 gauge (0.08mm²-1.31mm²). The power cord should be limited to less than 10 meters in order to ensure optimum performance.

Recommended 24V DC Power Supplies, similar to:
100VAC/240VAC: N-Tron series NTPS-24-1.3, DC 24V/1.3A

300 TX/FX Models Grounding Techniques

The grounding philosophy of any control system is an integral part of the design. N-Tron series switches are designed to be grounded, but the user has been given the flexibility to float the switch when required. The best noise immunity and emissions (i.e. CE) are obtained when the N-Tron switch chassis is connected to earth ground via a drain wire. Some N-Tron switches have metal DIN-Rail brackets that can ground the switch if the DIN-Rail is grounded. In some cases, N-Tron switches with metal brackets can be supplied with optional plastic brackets if isolation is required.

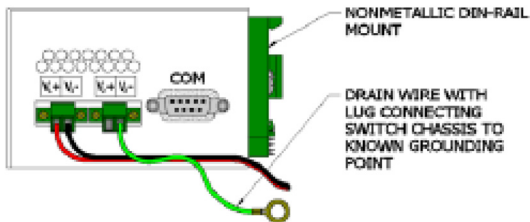

Both V- legs of the power input connector are connected to chassis internally on the PCB. Connecting a drain wire to earth ground from one of the V- terminal plugs as shown here will ground the switch and the chassis. The power leads from the power source should be limited to 3 meters or less in length.

As an alternate, users can run a drain wire & lug from any of the DIN-Rail screws or empty PEM nuts on the enclosure. When using an unused PEM nut to connect a ground lug via a machine screw, care should be taken to limit the penetration of the outer skin by less than 1/4 in. Failure to do so may cause irreversible damage to the internal components of the switch. Please note that the minimum cross-sectional area of the grounding conductor must be at least 14-18 gauge wire and it must be suitable for use in temperature of 110°C.

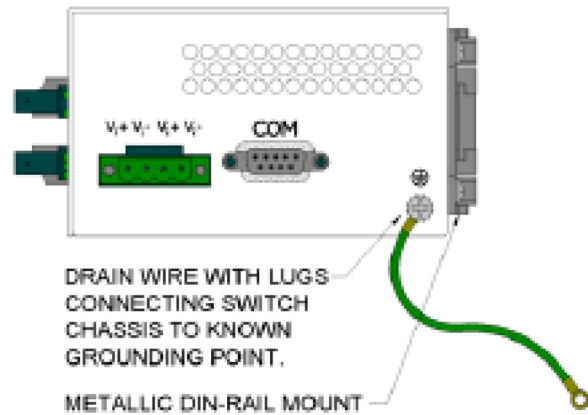

Note: Ensure the power supply is grounded properly before applying power to the grounded switch. This may be verified using a volt meter to verify there is no voltage difference between the power supply's negative output terminal and the switch chassis grounding point.

If the use of shielded cables is required, it is generally recommended to only connect the shield at one end to prevent ground loops and interfere with low level signals (i.e. thermocouples, RTD, etc.). Cat5e cables manufactured to EIA-568A or 568B specifications are required for use with N-Tron Switches.



In the event all Cat5e patch cable distances are small (i.e. All Ethernet devices are located the same local cabinet and/or referenced to the same earth ground), it is permissible to use fully shielded cables terminated to chassis ground at both ends in systems void of low level analog signals.

RJ45 Connector Crimp Specifications

Please reference the illustration below for the Cat5 cable specifications:

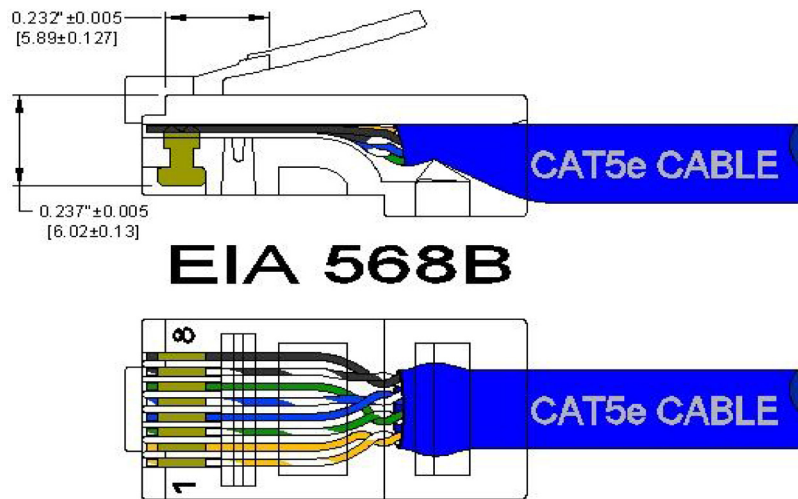

Connecting the Unit

For FX/FXE units, remove the dust cap from the fiber optic connectors and connect the fiber optic cables. The TX port on the FX/FXE models should be connected to the RX port of the far end station. The RX port on the FX/FXE models should be connected to the TX port of the far end station.

For 10/100 Base-TX ports, plug a Category 5e twisted pair cable into the RJ45 connector. Connect the other end to the far end station. Verify that the LNK LED's are ON once the connection has been completed. To connect any other port to another Switch or Repeater, use a standard Cat5 straight through or crossover cable.



CAUTION: Creating a port to port connection on the same switch (i.e. loop) is an illegal operation and will create a broadcast storm which will crash the network!

ATTENTION: la création d'un port à l'autre connexion sur le même commutateur (c'est-à-dire boucle) est une opération illégale et créera une tempête de diffusion qui va planter le réseau!

Note: For units having the **N-View Option**, you can validate that all ports are working correctly by installing the N-View OPC Server software. The software is freely distributed on the Product CD and our website (<http://www.redlion.net/support/software-firmware>). Once the software is installed, you should view the Ports Counter page to remotely monitor each connected port. You may find it helpful to copy [Alt]+[Print Screen] the Port Counter information for each port and paste [Control]+[V] into a Windows document for further review. Please consult your N-View OPC Server Manual for additional information.

Serial Interface

The 308FX2/309/316/317 switches provide an EIA-232 interface accessed via a 9 pin female connector (labeled 'COM' on the unit). This is used to access the Command Line Interpreter (CLI). The pin-outs are shown below:

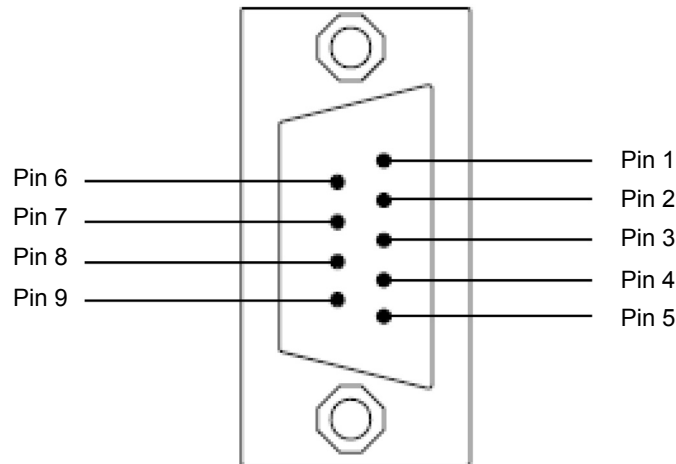

Serial Cable

Connect the serial COM port of your PC and the 308FX2/309/316/317 switch using a standard straight through cable. You will require a cable with a 9-pin or 25-pin sub-D female connector for the PC end, and a 9-pin male sub-D connector for the 308FX2/309/316/317 end.

Table 7 shows the pin-out and the connections for both types of cable.

Table 7. Serial Cable Pin-Outs

PC Port	25-Pin Female	9-Pin Female	308FX2/309/316/317 9-Pin Male	Signal Name
Signal Name	Pin Number	Pin Number	Pin Number	Signal Name
TXD	2	3	3	RXD
RXD	3	2	2	TXD
GND	7	5	5	GND

Shielded cables and null modems are readily available from a variety of electronics and computer suppliers.

Hyper Terminal

Use the configuration shown in Table 8 in Hyper Terminal:

Table 8. Hyper Terminal Configuration

Port Settings:	9600
Data Bits:	8
Parity:	None
Stop Bits:	1
Flow Control:	None

Section 3 Operation and Maintenance

Introduction

This section provides information on the 300 TX/FX models device ports and LED indicators function, device operation, and basic maintenance and troubleshooting guidelines.

300 TX/FX Models Ports and Indicators

The 300 TX/FX models ports and LED indicators, and a description of their functions, are identified in [Table 9](#).

Table 9. 300 TX/FX Models Front Panel

Port/LED	Description
LNK	Link LED for Fiber Optic Port (FX/FXE models only)
TX	100MB/s Fiber Optic Transmit Port (FX/FXE models only)
RX	100MB/s Fiber Optic Receive Port (FX/FXE models only)
ACT	Activity LED for Fiber Optic Port (FX/FXE models only)
RJ45 Ports	Auto sensing 10/100BaseTX Connections
	Green LED lights when Power is connected



NOTE: Each RJ45 data port has two LED's located at the top or bottom of each connector. The bottom LED indicates LINK status (green for 100Mb link, Orange for 10Mb link), and the top LED indicates ACTIVITY (Green for Full Duplex activity, Orange for Half Duplex Activity).

300 TX/FX Models LED's and Operating Modes

The 300 TX/FX models LED's and a description of the associated operating mode is presented in [Table 10](#).

Table 10. Unit LED's

LED	Color	Description
	Green	Power is applied
	OFF	Power is off
LNK	Green	100Mb Link between ports established
	Orange	10Mb Link between ports established
	OFF	No link between ports
ACT	Green	Data is active between ports and operating in full duplex
	Orange	Data is active between ports and operating in half duplex
	OFF	Data is inactive between ports

Software Configuration

Command Line Interpreter (CLI)

You can configure and/or query all the important parameters of an N-Tron® series 308FX2/309/316/317 Industrial Ethernet switch using a Command Line Interpreter (CLI). These functions are accessible using the serial port (marked COM).

To access the CLI

1. Connect a PC serial port to the 308FX2/309/316/317 V24 serial port and use HyperTerminal or equivalent.
2. Set COM Parameters to: 9600, 8, none, 1, none
3. After a successful connection and reboot, the boot menu should display:

```

Self Test & System Initialization Complete..... OK!

N-TRON Industrial Ethernet Switch - Model Number: 317 FX-N.
N-Tron firmware version : 1.01 (03,03)
Copyright (c) 2010 N-TRON

MAC ADDRESS: 00-07-AF-11-22-33

N-View is ENABLED.

Login - (Enter Username)>
    
```

N-View is enabled on a –N unit.

4. The displayed information includes the model number, firmware version, and MAC address.
5. Also, information is presented as to which functions are enabled, for example in this case above:
 - **N-View™** is reported as enabled (default).

Logging In (password protection)

Access using the CLI is password-protected. You can log in as administrator to read and modify the 308FX2/309/316/317 switch parameters.

Note: The **admin** password is **admin**.

1. On a 308FX2 switch, you must first press **<Escape>** to access the Management Console Function.
2. **Login:** enter username '**admin**' and press <Enter>.
3. **Password:** enter password '**admin**' and press <Enter>.
4. The screen should display the CLI prompt.

(See section on user defined password)

```
Self Test & System Initialization Complete..... OK!

N-TRON Industrial Ethernet Switch - Model Number: 308FX2-N.
N-Tron firmware version : 1.01 (03)
Copyright (c) 2010 N-TRON
MAC ADDRESS: 00-07-AF-12-89-12

N-View is ENABLED.

Managing Switch.....

Exit to return to Management Console Function.

Press [ESC] to Exit >

*** Now in user interface mode. ***

*** Managing Switch will resume after power is cycled. ***

Login - (Enter Username)> admin
Username is correct.

Login continued - (Enter Password)> *****
Password is correct.

CUSTOMER USER VALIDATED.

/          (Go to top of menu tree)
?          (Show menus/commands)

info       (Show identification data)
SYSTEM    (Open system menu)
SWITCH    (Open switch menu)

CLI>
```

5. You can now activate the commands of the CLI.

CLI Navigation

The following sections present the CLI menu tree and available CLI menus and commands.

CLI Menu Tree

- **info** (Show identification data)
- **SYSTEM** (Open system menu)
 - **nview** (Get information about N-View function)
 - info (Get information about N-View)
 - enable/disable (Enable/Disable N-View)
 - **info1** (Get information about system - ports 1->8)
 - **info2** (Get information about system - ports 9->16)
 - **restore** (Restore factory defaults) **Note: Power cycle is required when completed.
- **SWITCH** (Open switch menu)
 - **ports** (Reconfigure Individual Port Parameters)
 - info (Get info on Port Parameters)
 - enabling (Enable or disable each port)
 - negotiate (Select autonegotiate or not for each port)
 - speed10 (Force 10 Mb speed for each port)
 - speed100 (Force 100 Mb speed for each port)
 - half (Force half duplex for each port)
 - full (Force full duplex for each port)
 - crossover (Force crossover connection for each port)
 - **filters** (Select traffic filter(s)) 'filters' are on 308FX2 only
 - info (Get info on Filters)
 - dis_nring (Disable filters for N-Ring) (or 'en_nring' if currently disabled)
 - dis_ring600 (Disable filters for 600 ring) (or 'en_ring600' if currently disabled)

CLI Menus and Commands

The commands listed in [Table 11](#) are available at all menus.

Table 11. Universal Commands

Command	Description	Comment
/ or \	Returns you to the top of the menu tree (available in every menu)	Home function
?	Displays the current menu again (available in every menu)	Refresh function
u or U	Takes you up one level in the menu tree	



Home Menu

You can display all the other menus from the Home (start) menu. The Home menu is displayed immediately after you login and includes the commands in [Table 12](#).

Table 12. Home Menu Commands

Command	Description	Comment
info	Displays information about the switch	Displays the model number, firmware version, MAC address, and whether or not the N-View function is enabled
System	Opens the SYSTEM menu	The SYSTEM menu is used to set the system parameters
Switch	Opens the SWITCH menu	You can select settings for the switch in this menu

Home Menu Info Command

The Home Menu Info command invokes a screen display of the Model Number, Firmware version, MAC Address, and whether or not the N-View function is enabled.

```

CLI>info

N-TRON Industrial Ethernet Switch - Model Number: 308FX2-N.
N-Tron firmware version : 1.01 (03)
Copyright (c) 2010 N-TRON
MAC ADDRESS: 00-07-AF-12-89-12

N-View is ENABLED.

CLI>
    
```

System Menu

The System Menu commands Includes the following in [Table 13](#).

Table 13. System Menu Commands

Command	Description	Comment
nview	Get information about N-View function	Displays the model number, firmware version, MAC address, and whether or not the N-View function is enabled
Info or info1, info2...	Displays the current system status. (info for 308FX2/309) (Info1, 2 for 316/317)	LINK Status, Rate, Flow, etc.
Restore	Restores the default settings of the switch (complete reset). NOTE: Power cycle is required when completed.	Restores factory settings of the switch. With the exception of the “protected settings” (see “Restoring Defaults”), the settings made by the user are reset to the default values.



N-View™ Menu

With the **N-View™** OPC software and an appropriate OPC viewer, you can monitor port and switch status via the LAN. When enabled, periodic Multicast MAC packets are sent out from every port.

The available System Menu commands are described in [Table 14](#).

Table 14. N-View Menu Commands

Command	Description	Comment
info	Displays the current values of the switch settings	MAC address, enabled or disabled
Disable (or enable)	Enable or disable N-View	Choice is opposite of current state

Note: With the '-N' option all ports have N-View 'enabled' in defaults, but can be it can be disabled. Rate for generation of MIB information frames is ~6.4 seconds. The FX Port is mapped to port 9 on the 309, and as port 17 on the 317. On the 308FX2, ports 7 and 8 are FX ports.

```

CLISYSTEM\N-VIEW>info

N-View is ENABLED.

MAC ADDRESS:00-07-AF-00-05-26

/           (Go to top of menu tree)
?           (Show menus/commands)

info        (Get information about N-View)
disable     (Disable N-View)

CLISYSTEM\N-VIEW>
    
```

Literally thousands of switches in one normal LAN can have N-View enabled without negative impact, but for LANs that include extremely low bandwidth wireless links N-View can be disabled.

System Info Menu

System info provides information on each port, as shown in the example below. Note that this is real time status, and some parameters (such as Rate, Duplex, and Crossover) will oscillate if not linked and not forced. To see forced settings, go to switch/ports/info. See the sample “info” screen below.

```

CLLSYSTEM->info3

SYSTEM INFORMATION
PORT  17    18    19    20    21    22    23    24
-----
LINK  DOWN  DOWN  DOWN  DOWN  DOWN  UP    DOWN  DOWN
Enabled  ON    OFF  ON    ON    ON    ON    ON    ON
Negotiate ON    ON    OFF  ON    ON    ON    ON    ON
Rate    ---    ---  10    ---    ---  100  ---    ---
Duplex  ---    ---  HALF  ---    ---  FULL  ---    ---
Crossover NO    NO    NO    YES  NO    YES  YES  NO
NView  ON    ON    ON    ON    ON    ON    ON    ON
CLLSYSTEM->
    
```

Restore (Restoring Defaults)

The “restore” command restores the switch to factory default settings and has these affects:

- All ports are enabled.
- All RJ45 ports are set for auto-sensing. All FX ports are set to 100 MHz and Full Duplex.
- All RJ45 ports are set to auto-MDIX (as opposed to enabling crossover only).
- **N-View™** is enabled on –N units.
- On the 308FX2, both ring filters are enabled.

The MAC address, model number, and firmware version are protected settings. These settings are unaffected by restoring factory defaults.

Switch Menu

The available Switch Menu commands are described in [Table 15](#).

Table 15. Switch Menu Commands

Command	Description
ports	Reconfigure individual port parameters
filters	Select traffic filters



Ports Commands

By default, the RJ45 ports are auto-sensing for speed, duplexing, and crossover or straight through wiring. When you select ANY 'forced' option, the auto-sensing for that port is disabled for all three parameters and the 'remaining' (unforced) options are set to 100 Mbps, Full Duplex, and straight through cabling. For example, if you select speed10 for port 2, then port 2 will be: speed10, full duplex, and straight through wiring. If you need 'half duplex' also on port 2, you will have to select it also as auto-sensing will be disabled for port 2 after you forced speed10. The FX ports are always 100 Mb, and Full Duplex.

Note: In a LAN it is best to set ALL devices at autonegotiate, or to set ALL devices to the same mode (speed/duplex).

If one end of a link is set to forced speed/duplex, but the other end is not forced, problems can be created.

On the 308FX2, 309, 316, or 317, it is possible to autonegotiate, or force to any of 4 modes: 100 full, 100 half, 10 full, or 10 half.

If you force one unit into 10/full, and leave another in autonegotiate (the default), the unit in autonegotiation does not go into 10 full mode. It goes into 10 half. It gets no autonegotiation response. It easily senses speed passively, but has no way to sense duplex mode and so uses the "safest" duplex mode - half. This is in accordance with the IEEE specification. Thus, you have one unit at 10 full and the other at 10 half - basically functional but not ideal. The unit at 10 full transmits without checking for busy and you get more data collisions. Also, the 10/full unit does not back off or retransmit based on the collision domain.

The same problem results with one unit forced to 100/full and the other autonegotiating. The autonegotiating unit goes into 100/half mode.

The available "ports" commands are listed and described in [Table 16](#).

Table 16. Ports Commands

Command	Description	Next Prompt
info	Get information on port parameters	
enabling	Enable or disable each port	
negotiate	Select autonegotiate or not for each port	Enter ports that are to autonegotiate:
speed10	Force 10 Mb speed for each port	Enter forced 10 Mb ports:
speed100	Force 100 Mb speed for each port	Enter forced 100 Mb ports:
half	Force half duplex mode for each port	Enter forced Half duplex ports:
full	Force full duplex mode for each port	Enter forced Full Duplex ports:
crossover	Force crossover connection for each port	Enter forced crossover ports:

Each time a forced port function is selected (speed, duplex, or crossover) the ports entered next are the complete new set of ports for that function. For example, if you enter 'speed10', then respond with only <enter> (no ports) to the prompt "Enter forced 10 Mb ports:", then no ports in the switch will be forced to 10 Mb, regardless of prior history.



Refer to the screens that follow for examples of executing each port command.

Example of the Ports enabling screen:

```
CLI\SWITCH\PORTS>enabling

Enter ports to enable>
Use commas to separate port numbers. (Example: '3,6,12,14,22<enter>'.)
Enter Port Numbers (or ESC to exit):1,2,3,4,9,10,11,12,13

CLI\SWITCH\PORTS>
```

Example of the negotiate screen:

```
CLI\SWITCH\PORTS>negotiate

Enter ports that are to autonegotiate>
Use commas to separate port numbers.
(Example: '3,6,12,14<enter>'.)
Enter Port Numbers (or ESC to exit)> all

CLI\SWITCH\PORTS>
```

Example of the Ports speed10 screen:

```
CLI\SWITCH\PORTS>speed10

Enter forced 10 Mb ports>
Use commas to separate port numbers. (Example: '3,6,12,14<enter>'.)
Enter Port Numbers (or ESC to exit):5

CLI\SWITCH\PORTS>
```

Example of the Ports half (duplex) screen:

```
CLI\SWITCH\PORTS>half

Enter forced Half Duplex ports>
Use commas to separate port numbers. (Example: '3,6,12,14<enter>'.)
Enter Port Numbers (or ESC to exit):5

CLI\SWITCH\PORTS>
```

Example of the Ports crossover screen:

```
CLI\SWITCH\PORTS>crossover

Enter forced crossover ports>
Use commas to separate port numbers. (Example: '3,6,12,14<enter>'.)
Enter Port Numbers (or ESC to exit):2

CLI\SWITCH\PORTS>
```

Filters Commands

On the 308FX2 only, filters are provided and enabled in defaults to keep ring control frames only on the ring ports. The available “filters” commands are described in [Table 17](#).

Table 17. Filters Commands

Command	Description	Comment
en_nring, or dis_nring	N-Ring filter	308FX2 ONLY Ports 7 and 8 are ring ports
en_ring600, or dis_ring600	600 series ring filter	308FX2 ONLY Ports 7 and 8 are ring ports

The N-Ring and 600 Series Ring filters are on the 308FX2 only, and are either enabled or disabled. The command choice presented is the opposite of the current state.

After entering ‘bfilter’, you will be asked to:
“Enter ports that are to receive General Broadcast frames:

Refer to the screens that follow for examples of executing each filters command.

```

Example of the Filters choices screen (308FX2 ONLY):
CLI\SWITCH>filters
/                (Go to top of menu tree)
?                (Show menus/commands)

info            (Get info on Filters)
dis_nring      (Disable filters for N-Ring)
dis_ring600    (Disable filters for 600 series ring)

CLI\SWITCH\FILTERS>
    
```

```

Example of the Filters info screen (308FX2 ONLY):
CLI\SWITCH\FILTERS>info

N-Ring filter is Enabled. Ports 7 and 8 are ring ports.
600 series ring filter is Enabled. Ports 7 and 8 are ring ports.

CLI\SWITCH\FILTERS>
    
```

Trouble Shooting

The following procedure provides some guidelines to assist in identifying hardware issues that might be affecting unit performance.

1. Ensure the (Power LED) is ON.
2. Make sure you are supplying sufficient current for the version chosen.
3. Verify that Link LED's are ON for connected ports.
4. Verify cabling used between stations.



5. Verify that cabling is Category 5E or greater for 100Mbit Operation.
6. For FX/FXE models, verify TX is connected to the far end RX and vice versa. Also ensure the connecting partner is 100Mb/s IEEE 100BaseFX compliant.

Note: The 308FX2/309/316/317 FX/FXE switches do not support the 10BaseFL standard.

Cleaning

Clean unit only with a damp cloth.

Maintenance

There are no user serviceable parts inside the unit. Removing the top cover will void the warranty.

N-Tron® Series 300 TX/FX Models Limited Warranty

a) Red Lion Controls Inc., Sixnet Inc., N-Tron Corporation, or Blue Tree Wireless Data, Inc. (the "Company") warrants that all Products shall be free from defects in material and workmanship under normal use for the period of time provided in "Statement of Warranty Periods" (available at www.redlion.net) current at the time of shipment of the Products (the "Warranty Period"). **EXCEPT FOR THE ABOVE-STATED WARRANTY, COMPANY MAKES NO WARRANTY WHATSOEVER WITH RESPECT TO THE PRODUCTS, INCLUDING ANY (A) WARRANTY OF MERCHANTABILITY; (B) WARRANTY OF FITNESS FOR A PARTICULAR PURPOSE; OR (C) WARRANTY AGAINST INFRINGEMENT OF INTELLECTUAL PROPERTY RIGHTS OF A THIRD PARTY; WHETHER EXPRESS OR IMPLIED BY LAW, COURSE OF DEALING, COURSE OF PERFORMANCE, USAGE OF TRADE OR OTHERWISE.** Customer shall be responsible for determining that a Product is suitable for Customer's use and that such use complies with any applicable local, state or federal law.

(b) The Company shall not be liable for a breach of the warranty set forth in paragraph (a) if (i) the defect is a result of Customer's failure to store, install, commission or maintain the Product according to specifications; (ii) Customer alters or repairs such Product without the prior written consent of Company.

(c) Subject to paragraph (b), with respect to any such Product during the Warranty Period, Company shall, in its sole discretion, either (i) repair or replace the Product; or (ii) credit or refund the price of Product provided that, if Company so requests, Customer shall, at Company's expense, return such Product to Company.

(d) **THE REMEDIES SET FORTH IN PARAGRAPH (c) SHALL BE THE CUSTOMER'S SOLE AND EXCLUSIVE REMEDY AND COMPANY'S ENTIRE LIABILITY FOR ANY BREACH OF THE LIMITED WARRANTY SET FORTH IN PARAGRAPH (a).**



