



## Color Variations and Luminous Intensity

(Ta=25°C)

Part No.	Material	Emitted Color	Lens Color	Dominant Wavelength		Luminous Intensity			Luminous Flux	
				$\lambda d$ (nm)		$I_v$ (mcd)			$\phi v$ (mlm)	
				TYP.	$I_f$	MIN.	MAX.	$I_f$	TYP.	$I_f$
VUB1111C	InGaN	Blue	Milky White	470	10	15	56	10	300	10
VUG1111C	InGaN	Green		530	10	47	180	10	700	10
VYBG1111C	AlGaInP			562	20	5.6	27	20	45	20
VYPY1111C	AlGaInP	Yellow Green		572	20	18	68	20	130	20
VFY1111C	AlGaInP	Yellow		590	20	39	150	20	300	20
VFA1111C	AlGaInP	Orange		605	20	39	120	20	300	20
VFV1111C	AlGaInP	Red		615	20	68	220	20	350	20
VFR1111C	AlGaInP			626	20	39	120	20	300	20

※Note : The luminous intensity( $I_v$ ) and dominant wavelength ( $\lambda d$ ) above are the setup values of the sorting machine.  
(Tolerance :  $I_v$ ...  $\pm 10\%$ ,  $\lambda d$  ...  $\pm 1$ nm)

## Absolute Maximum Ratings

(Ta=25°C)

Item	Symbol	Absolute Maximum Ratings								Unit
		VUB	VUG	VYBG	VYPY	VFY	VFA	VFV	VFR	
Power Dissipation	$P_d$	84	84	81	81	78	78	78	78	mW
Forward Current	$I_F$	20	20	30	30	30	30	30	30	mA
Pulse Forward Current <sup>※1</sup>	$I_{FRM}$	48	48	100	100	100	100	100	100	mA
Derating (Ta=75°C or higher)	$\Delta I_F$	0.40 <sup>※2</sup>	0.40 <sup>※2</sup>	1.0	1.0	1.0	1.0	1.0	1.0	mA/°C
	$\Delta I_{FRM}$	0.96 <sup>※2</sup>	0.96 <sup>※2</sup>	3.33	3.33	3.33	3.33	3.33	3.33	mA/°C
Reverse Voltage	$V_R$	5	5	5	5	5	5	5	5	V
Operating Temperature	$T_{opr}$	-40~+100								°C
Storage Temperature	$T_{stg}$	-40~+110		-40~+120						°C

※1  $I_{FRM}$  Measurement condition : Pulse Width  $\leq$  1ms., Duty  $\leq$  1/20.

※2 Temperature Condition: Ta=60°C or higher.

## Thermal Characteristics

Item	Symbol	Ratings								Unit
		VUB	VUG	VYBG	VYPY	VFY	VFA	VFV	VFR	
Junction Temperature (MAX.)	$T_j$	110	110	120	120	120	120	120	120	°C
Thermal Resistance (TYP.) (Junction/ ambient)	$R_{(th\ j-a)}$	500	500	600	550	550	550	550	550	°C/W
Thermal Resistance (TYP.) (Junction/ Solder Point)	$R_{(th\ j-s)}$	300	300	400	350	350	350	350	350	°C/W

※ $R_{(th\ j-a)}$  Measurement Condition / Substrate: FR4(t=1.6mm) Pattern Size: 16mm<sup>2</sup>.

## Electro-Optical Characteristics (VUB, VUG)

(Ta=25°C)

Item	Conditions	Symbol	Characteristic Ratings		Unit	
			VUB	VUG		
Forward Voltage	I <sub>F</sub> =10mA	V <sub>F</sub>	TYP.	3.3	3.3	V
			MAX.	3.8	3.8	
Reverse Current	V <sub>R</sub> =5V	I <sub>R</sub>	MAX.	100	100	μ A
Peak Wavelength	I <sub>F</sub> =10mA	λ <sub>p</sub>	TYP.	465	522	nm
Dominant Wavelength	I <sub>F</sub> =10mA	λ <sub>d</sub>	TYP.	470	530	nm
Spectral Line Half Width	I <sub>F</sub> =10mA	Δλ	TYP.	26	35	nm
Half Intensity Angle	I <sub>F</sub> =10mA	2θ 1/2	TYP.	150(θ x)	150(θ x)	deg.
				165(θ y)	165(θ y)	

※Note: The dominant wave length (λ<sub>d</sub>) above is the setup value of the sorting machine.  
(Tolerance : λ<sub>d</sub>...±1nm)

## Electro-Optical Characteristics (VYBG, VYPY, VFY, VFA, VFV, VFR)

(Ta=25°C)

Item	Conditions	Symbol	Characteristic Rating						Unit	
			VYBG	VYPY	VFY	VFA	VFV	VFR		
Forward Voltage	I <sub>F</sub> =20mA	V <sub>F</sub>	TYP.	2.1	2.1	1.9	1.9	1.9	1.9	V
			MAX.	2.5	2.5	2.4	2.4	2.4	2.4	
Reverse Current	V <sub>R</sub> =5V	I <sub>R</sub>	MAX.	100	100	100	100	100	100	μ A
Peak Wavelength	I <sub>F</sub> =20mA	λ <sub>p</sub>	TYP.	565	575	592	609	624	635	nm
Dominant Wavelength	I <sub>F</sub> =20mA	λ <sub>d</sub>	TYP.	562	572	590	605	615	626	nm
Spectral Line Half Width	I <sub>F</sub> =20mA	Δλ	TYP.	15	15	15	15	15	15	nm
Half Intensity Angle	I <sub>F</sub> =20mA	2θ 1/2	TYP.	120(θ x)	146(θ x)	140(θ x)	140(θ x)	140(θ x)	140(θ x)	deg.
				140(θ y)	146(θ y)	150(θ y)	150(θ y)	150(θ y)	150(θ y)	

※Note: The dominant wave length (λ<sub>d</sub>) above is the setup value of the sorting machine.  
(Tolerance : λ<sub>d</sub>...±1nm)

## Luminous Intensity Rank

(Ta=25°C)

### Standard Chart (Unit: mcd)

Rank	I <sub>v</sub> (mcd)		VUB	VUG	VYBG	VYPY	VFY	VFA	VFV	VFV	VFV	VFR
	MIN.	MAX.	I <sub>F</sub> =10mA			I <sub>F</sub> =20mA						
A7	3.3	3.9										
A8	3.9	4.7										
A9	4.7	5.6										
AX	5.6	6.8			AX							
AY	6.8	8.2										
AZ	8.2	10.0										
B1	10.0	12.0										
B2	12.0	15.0										
B3	15.0	18.0	B3									
B4	18.0	22.0				B4						
B5	22.0	27.0			B5							
B6	27.0	33.0										
B7	33.0	39.0										
B8	39.0	47.0					B8	B8	B8			B8
B9	47.0	56.0	B9	B9								
BX	56.0	68.0				BX						
BY	68.0	82.0									BY	
BZ	82.0	100.0										
C1	100.0	120.0						C1	C1			
C2	120.0	150.0					C2					C2
C3	150.0	180.0		C3								
C4	180.0	220.0									C4	
C5	220.0	270.0										
C6	270.0	330.0										
C7	330.0	390.0										
C8	390.0	470.0										
C9	470.0	560.0										

※ Limited width of luminous intensity rank is from Min.4 rank width.

## Color Tone Groups (λd)

(Ta=25°C)

( unit : nm )

Tolerance: +/-1nm

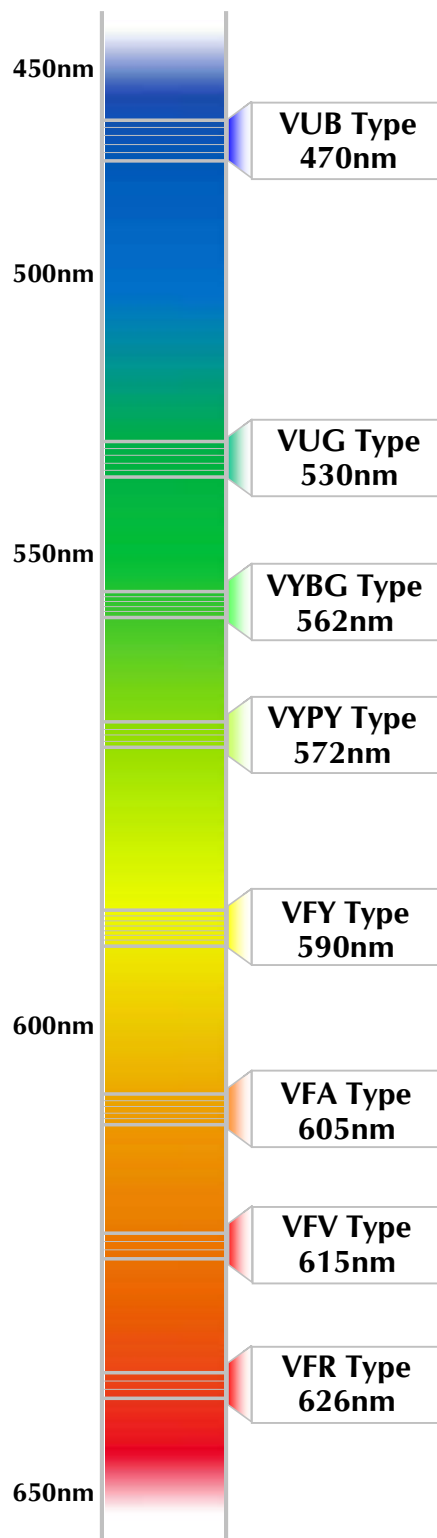

### VUB Type (I<sub>F</sub>=10mA)

	A	B	C	D
MIN.	460.0	464.0	468.0	472.0
MAX.	464.0	468.0	472.0	476.0

### VUG Type (I<sub>F</sub>=10mA)

	A	B	C	D
MIN.	515.0	520.0	525.0	530.0
MAX.	520.0	525.0	530.0	535.0

### VYBG Type (I<sub>F</sub>=20mA)

	B	C	D
MIN.	555.0	558.0	561.0
MAX.	558.0	561.0	564.0

### VYPY Type (I<sub>F</sub>=20mA)

	A	B	C
MIN.	567.0	570.0	573.0
MAX.	570.0	573.0	576.0

### VFY Type (I<sub>F</sub>=20mA)

	C	D	E	F
MIN.	583.0	586.0	589.0	592.0
MAX.	586.0	589.0	592.0	595.0

### VFA Type (I<sub>F</sub>=20mA)

	A	B	C	D
MIN.	597.0	600.0	603.0	606.0
MAX.	600.0	603.0	606.0	609.0

### VFV Type (I<sub>F</sub>=20mA)

	B	C	D
MIN.	613.0	616.0	619.0
MAX.	616.0	619.0	622.0

### VFR Type (I<sub>F</sub>=20mA)

	A	B	C
MIN.	620.0	626.0	632.0
MAX.	626.0	632.0	638.0

※Limited width of color tone rank is from Min.3 to Min.4 rank width.  
(It changes with product.)

## Characteristics Chart (VUB,VUG)

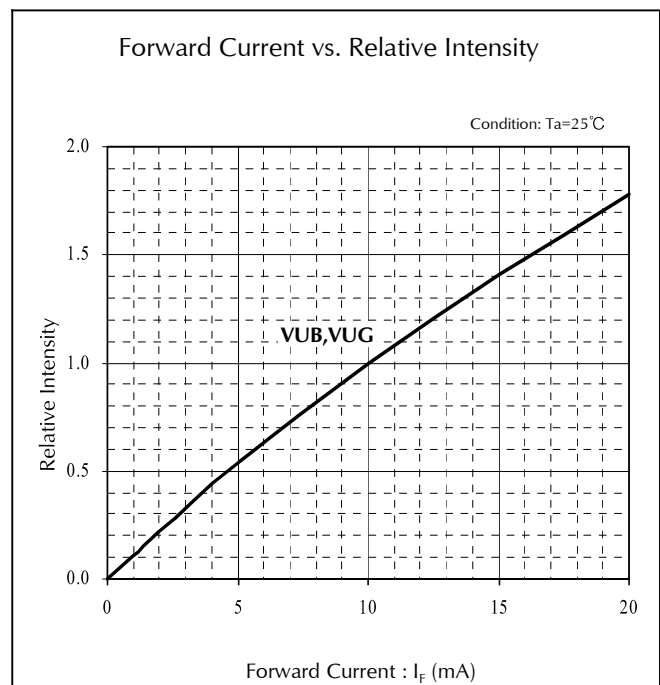
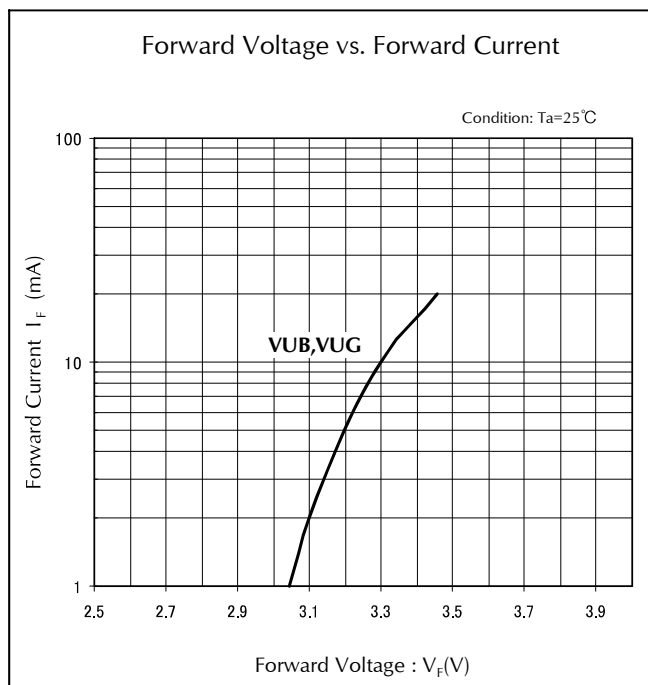
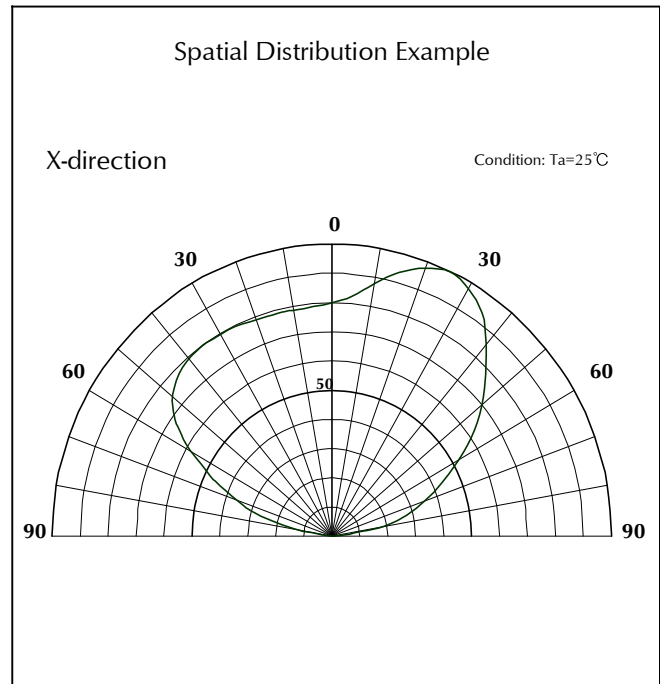
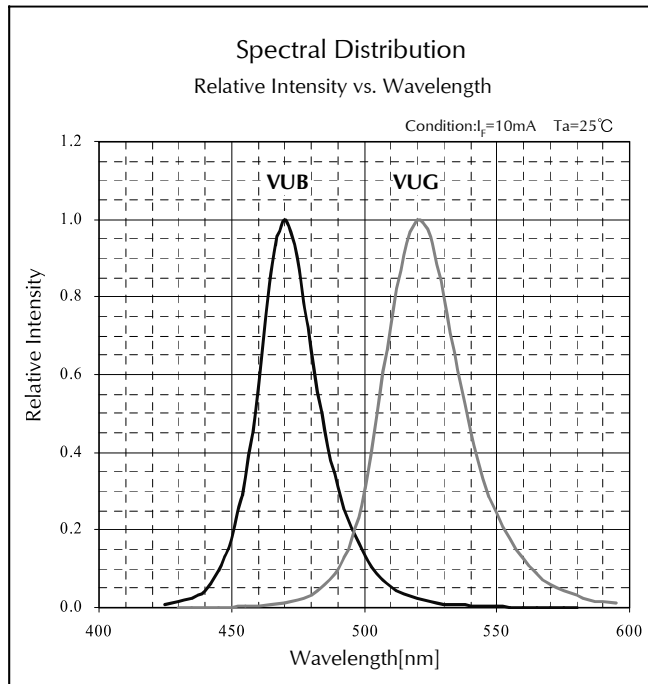

## Characteristics Chart (VUB,VUG)

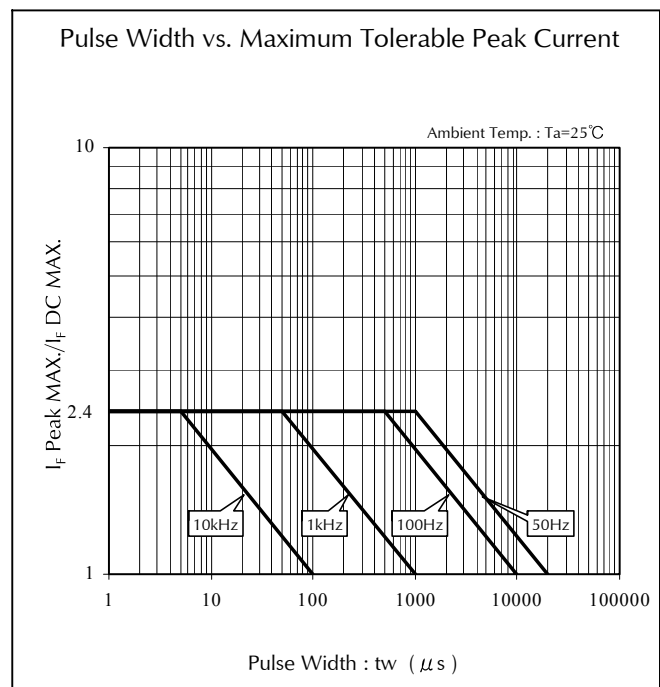
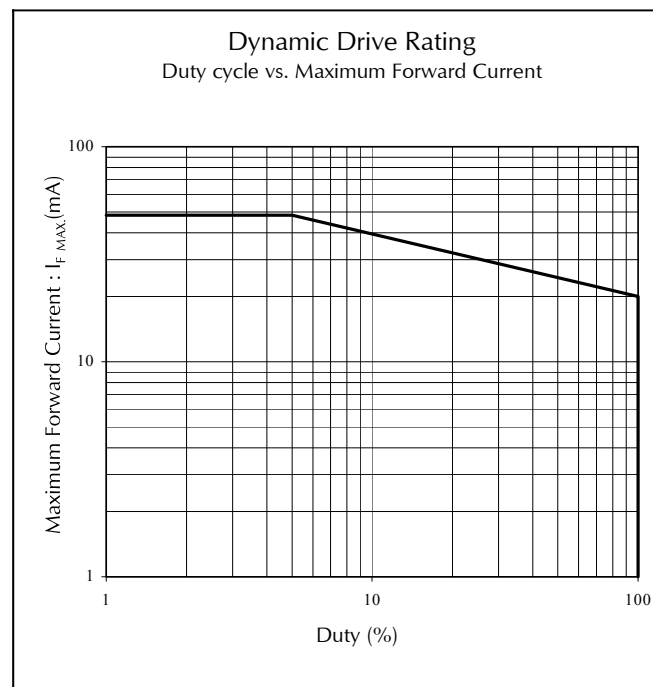
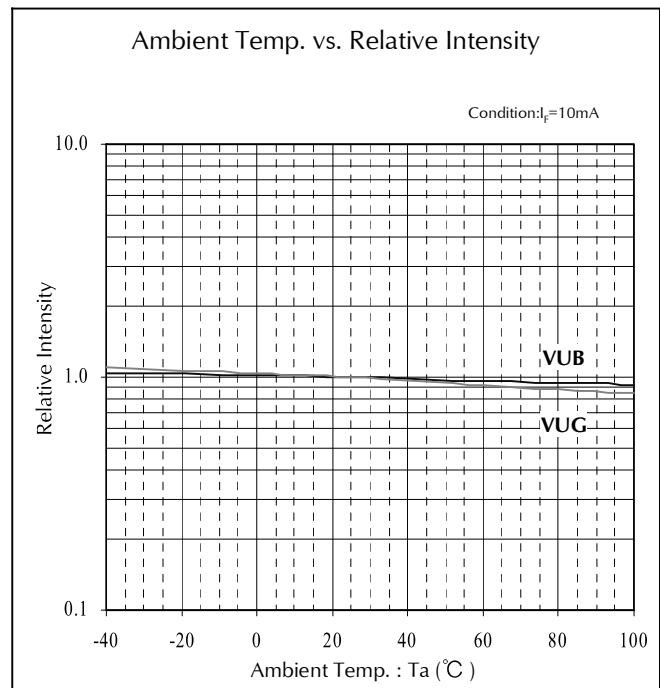
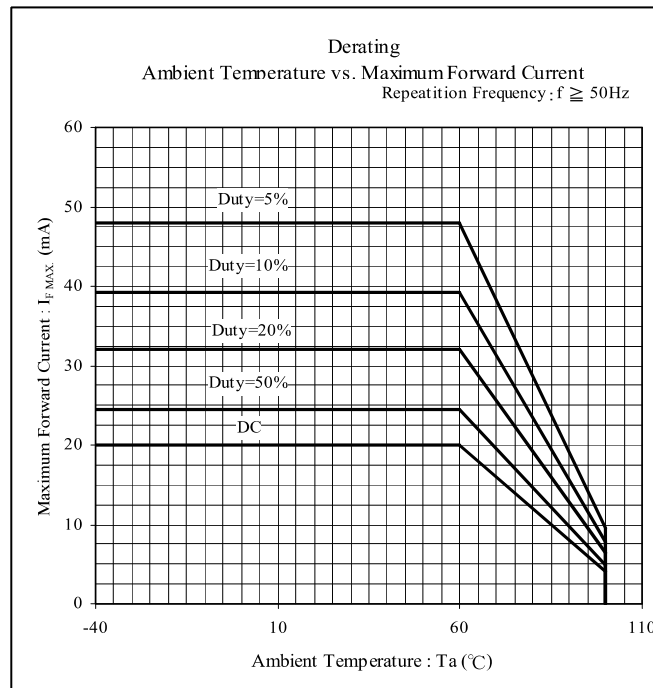



## Characteristics Chart (VYBG, VYPY)

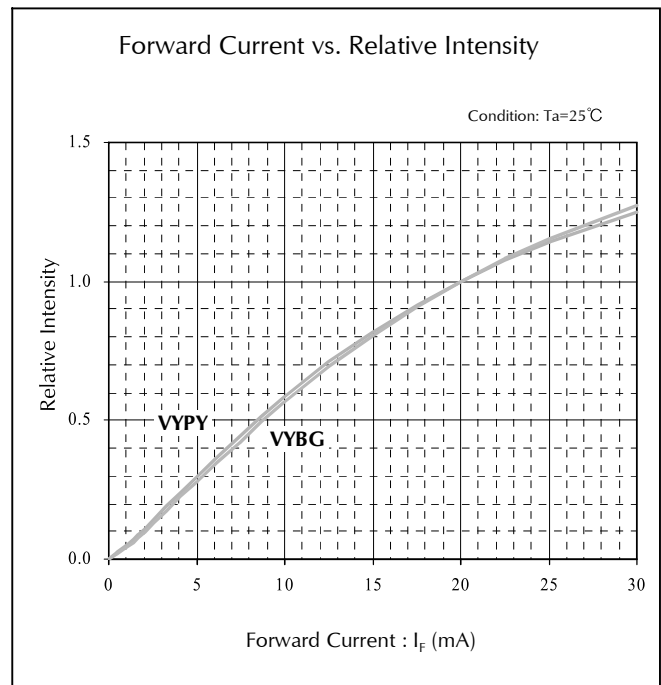
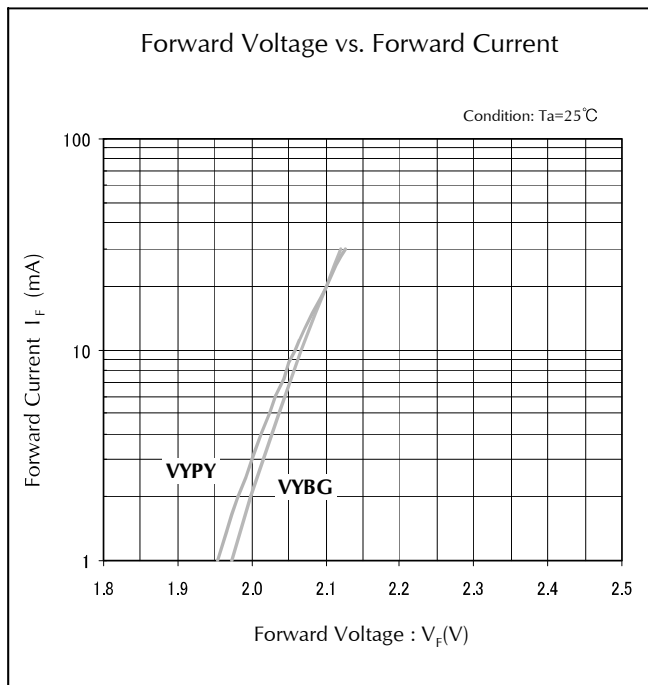
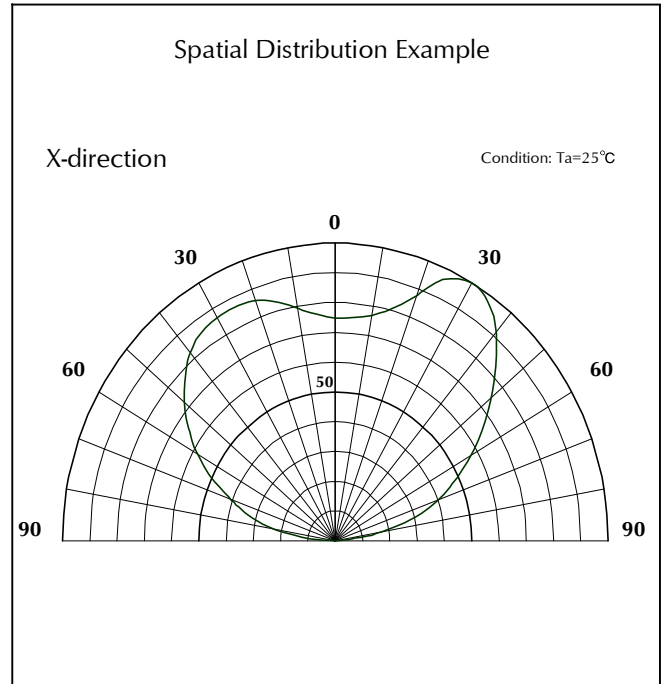
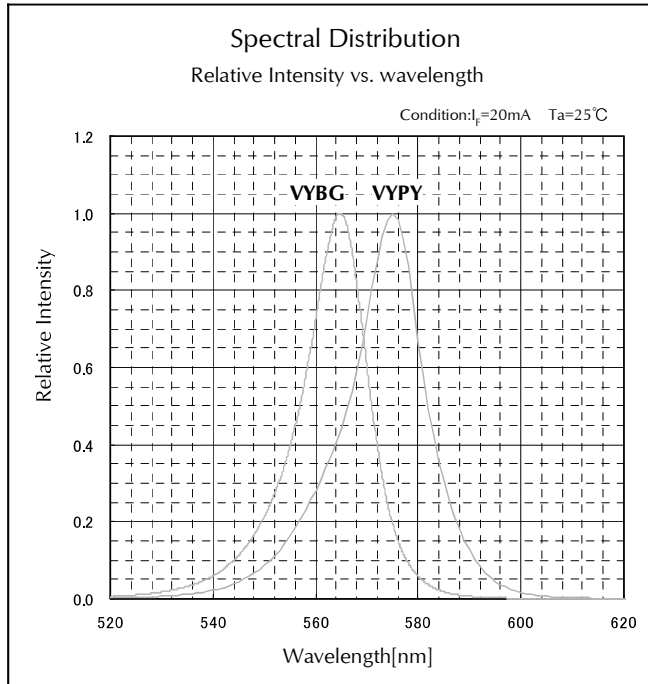

## Characteristics Chart (VYBG, VYPY)

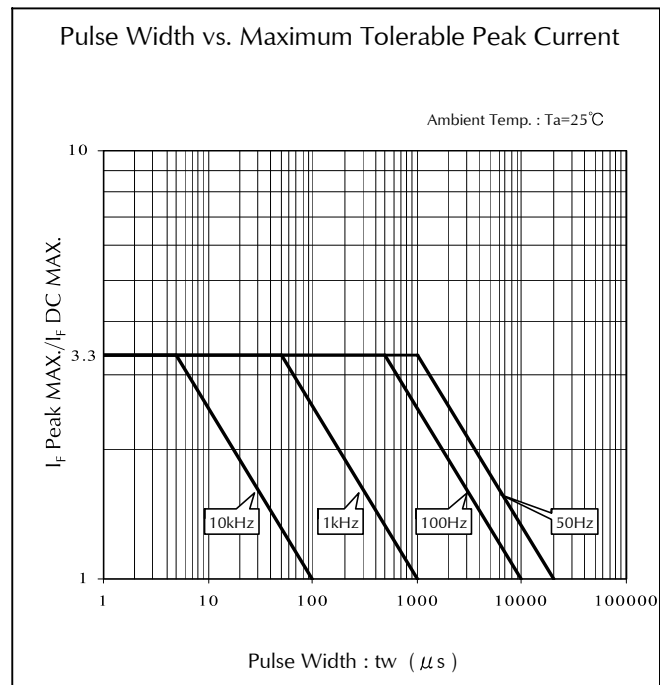
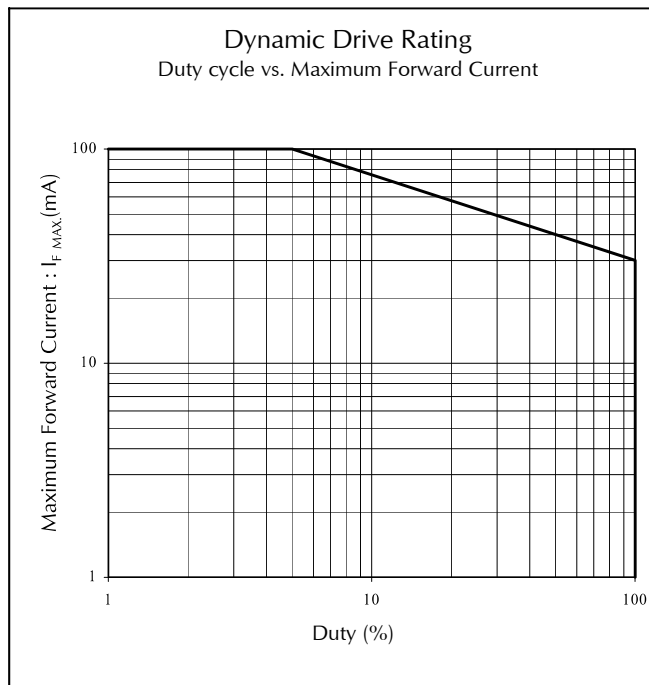
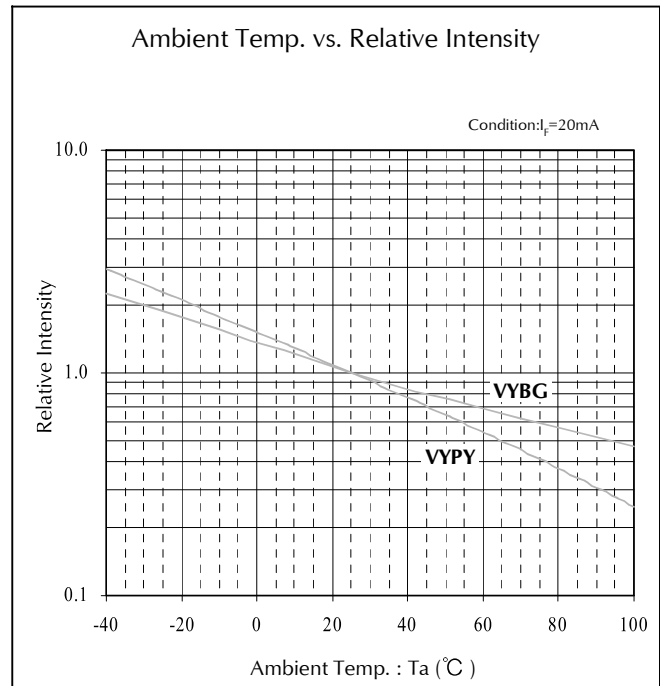
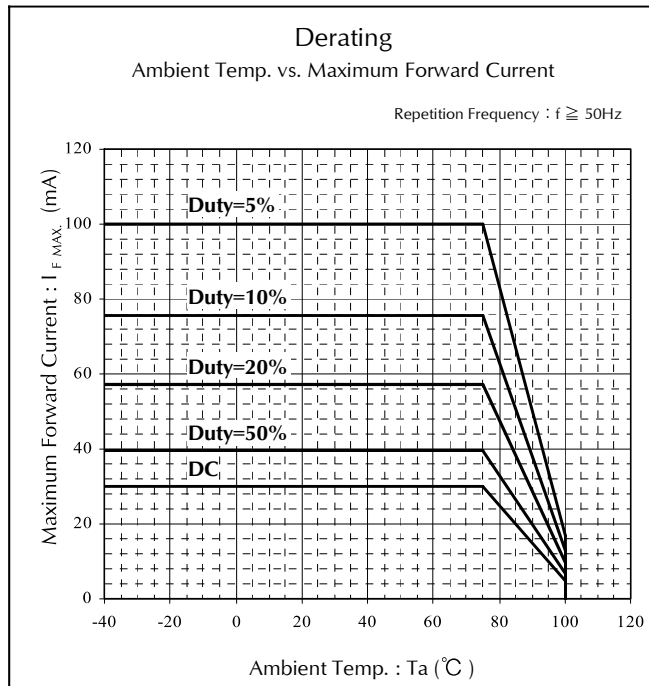

## Characteristics Chart (VFY,VFA,VFV,VFR)

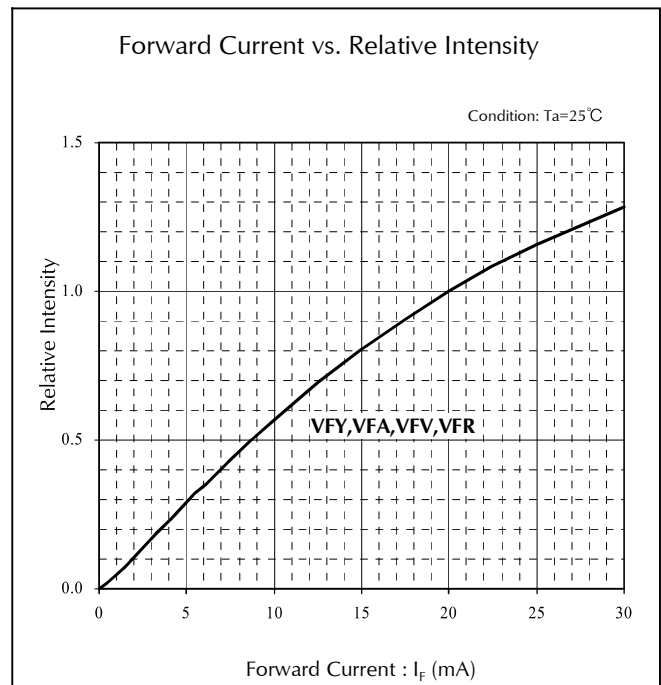
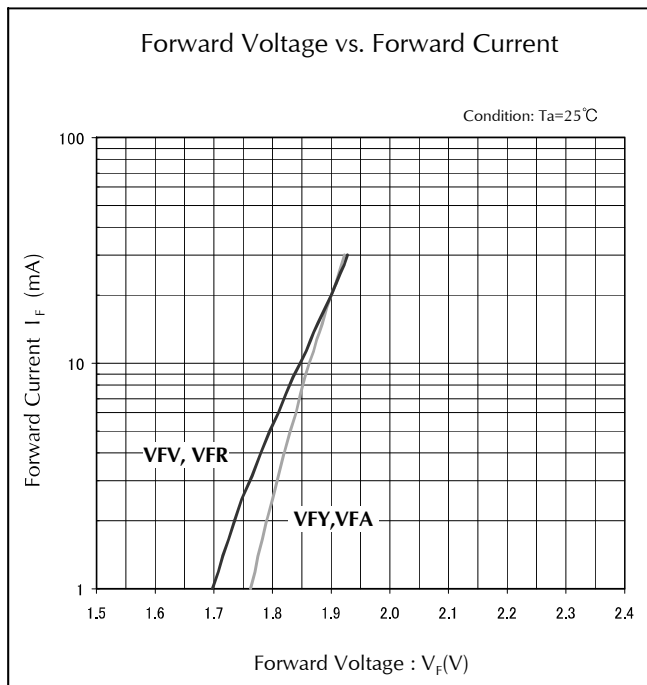
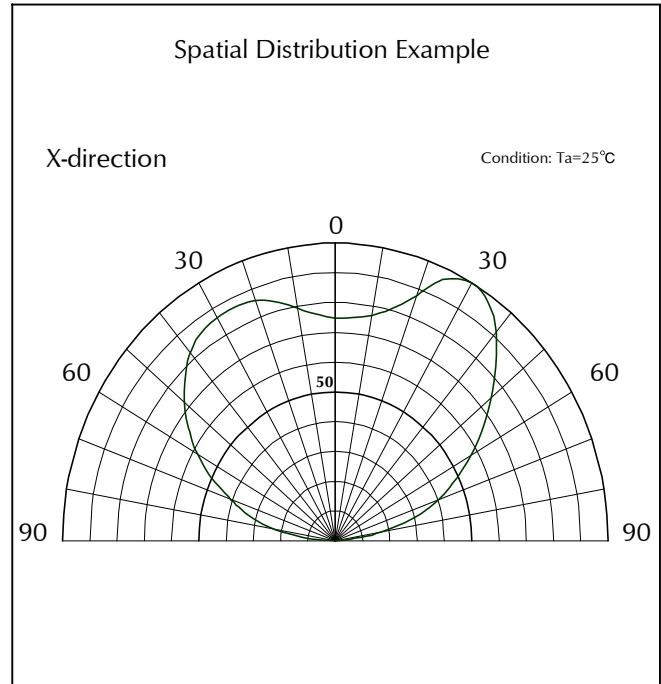
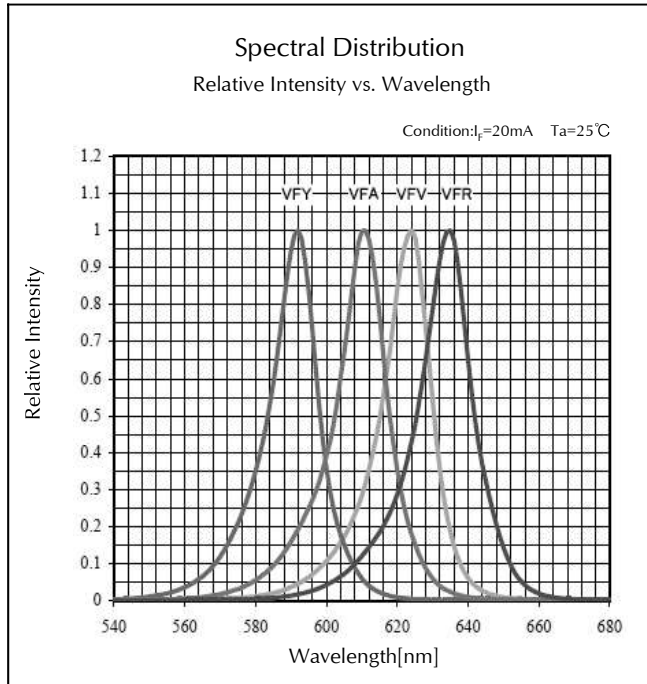

## Characteristics Chart (VFY, VFA, VFV, VFR)

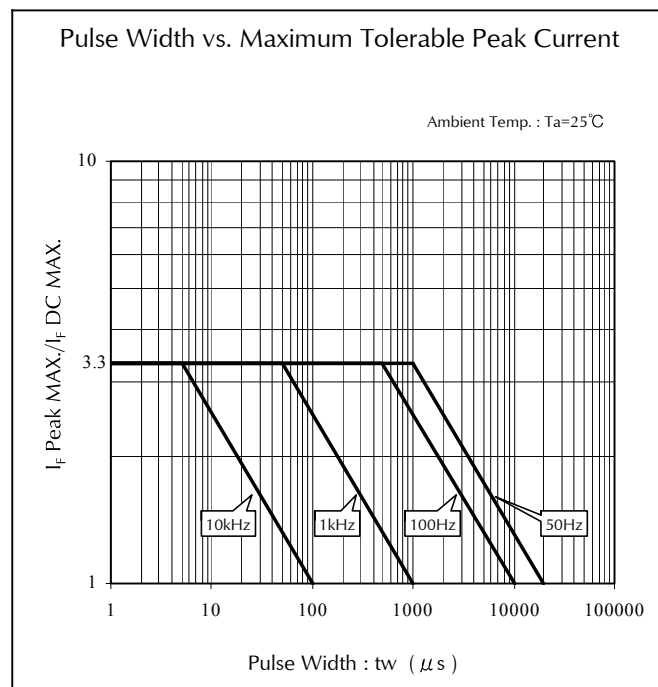
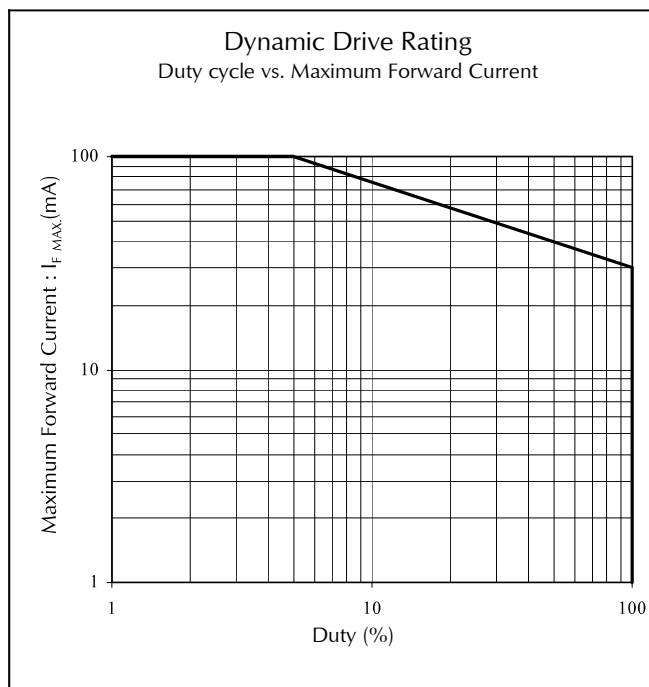
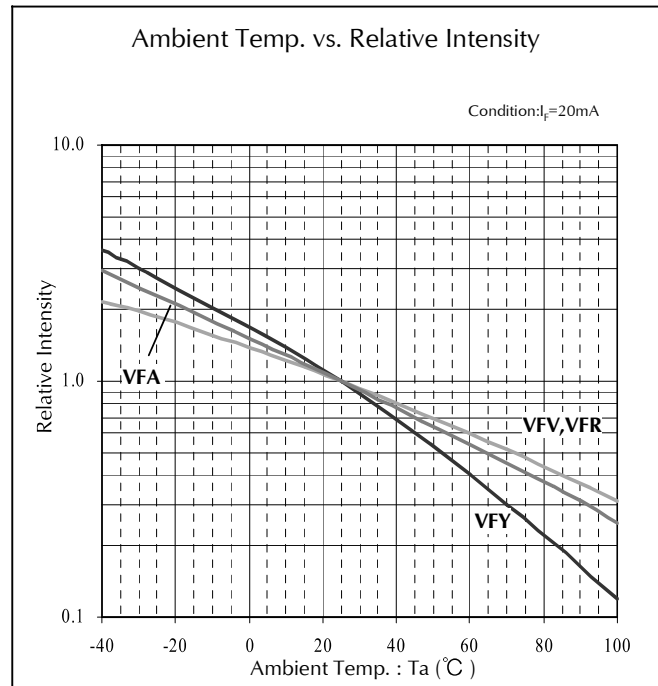
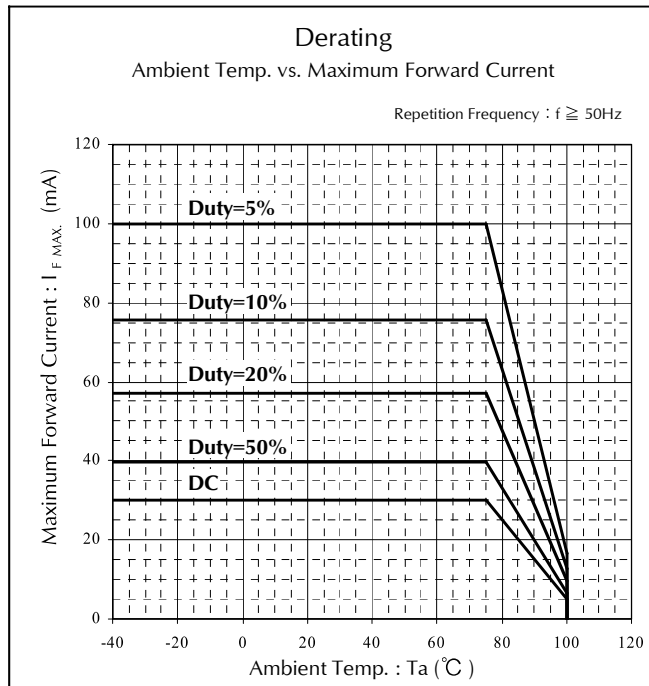

## Package Dimensions

(Unit: mm)

Weight: (1.40)mg

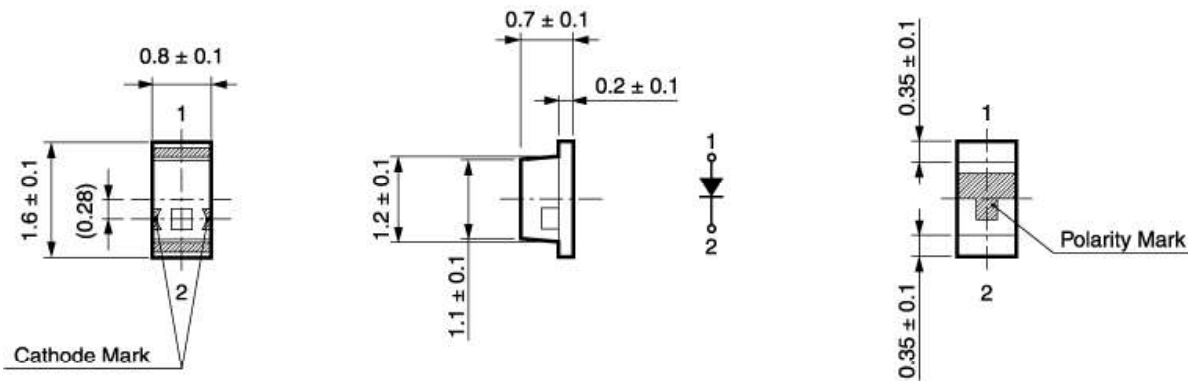

## Recommended Soldering Pattern

(Unit: mm)

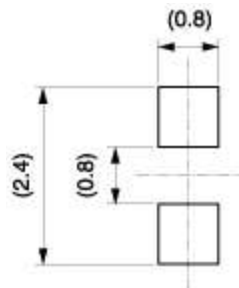

## Taping Specification

(Unit: mm)

•Quantity: 4,000pcs/ reel (standard)

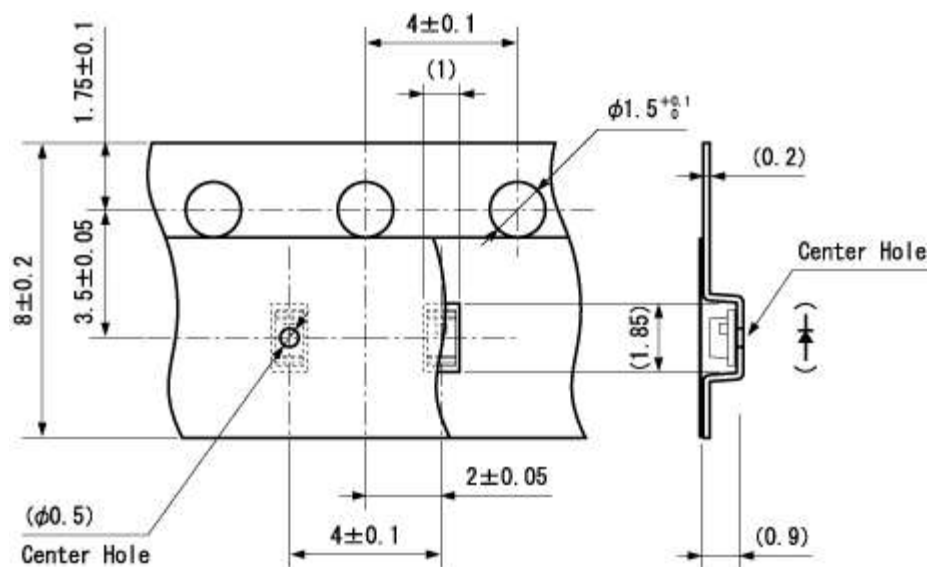

## Reflow Soldering Conditions

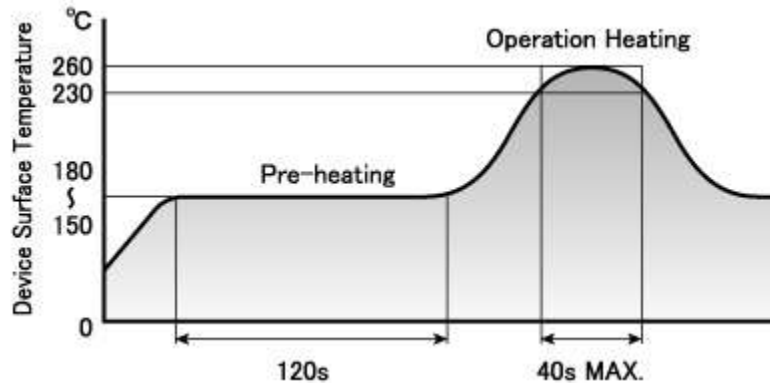

- 1) The above profile temperature gives the maximum temperature of the LED resin surface. Please set the temperature so as to avoid exceeding this range.
- 2) Total times of reflow soldering process shall be no more than 2 times. When the second reflow soldering process is performed, intervals between the first and second reflow should be short as possible (while allowing some time for the component to return to normal temperature after the first reflow) in order to prevent the LED from absorbing moisture.
- 3) Temperature fluctuation to the LED during the pre-heating process shall be minimized.

## Manual Soldering Conditions

Iron tip temp.	350 °C	(MAX.)
Soldering time and frequency	3 s	(MAX.)
	1 time	(MAX.)

## Reliability Testing Result

Reliability Testing Result	Applicable Standard	Testing Conditions	Duration	Failure
Room Temp. Operating Life	EIAJ ED-4701/100(101)	Ta = 25°C, If = Maximum Rated Current	1,000 h	0/20
High Temp. Operating Life	EIAJ ED-4701/100(101)	Ta = Maximum Rated Operating Temperature, If = Derating Value	1,000 h	0/20
Low Temp. Operating Life	EIAJ ED-4701/100(101)	Ta = -40°C, If = Maximum Rated Current	1,000 h	0/20
Wet High Temp. Operating Life	EIAJ ED-4701/100(102)	Ta = 60°C, 90%, If = Maximum Rated Current	1,000 h	0/20
Wet High Temp. Storage Life	EIAJ ED-4701/100(103)	Ta = 60°C, 90%	1,000 h	0/20
Thermal Shock	EIAJ ED-4701/100(105)	Ta = -40°C ~ Maximum Rated Storage Temperature (each 15min.)	1,000 cycles	0/20
Thermal Shock Operating	EIAJ ED-4701/100(105)	Ta = -40°C(off) ~ 85°C (If = Derating Value on), (each 15min.)	1,000 cycles	0/20
High Temp. Storage Life	EIAJ ED-4701/200(201)	Ta = Maximum Rated Storage Temperature	1,000 h	0/20
Low Temp. Storage Life	EIAJ ED-4701/200(202)	Ta = Minimum Rated Storage Temperature	1,000 h	0/20
Cycled Temp. Humidity Life	EIAJ ED-4701/200(203)	Ta = -30°C(2h) ~ 80°C, 95%(2h), 8h/cycle, If = Derating Value, 5min on-off	30 cycles	0/20
Resistance to Reflow Soldering	EIAJ ED-4701/300(301)	Moisture Soak : 30°C, 70%, 72h Preheat : 150 ~ 180°C(120s Max.) Soldering Temp. : 260°C(5s)	Twice	0/20
Electric Static Discharge (ESD) <sup>※1</sup>	EIAJ ED-4701/300(304)	C = 100pF, R2 = 1.5KΩ, ±2,000V	once each polarity	0/10
Vibration, Variable Frequency	EIAJ ED-4701/400(403)	98.1m/s <sup>2</sup> (10G), 100 ~ 2KHz, 20min, XYZ each direction	2 h	0/10

※1 Reference test

## Failure Criteria

Items	Symbols	Conditions	Failure criteria
Luminous Intensity	Iv	If Value of each product Luminous Intensity	Testing Min. Value < Spec. Min. Value x 0.5
Forward Voltage	Vf	If Value of each product Forward Voltage	Testing Max. Value ≥ Spec. Max. Value x 1.2
Reverse Current	Ir	Vr = Maximum Rated Reverse Voltage V	Testing Max. Value ≥ Spec. Max. Value x 2.5
Cosmetic Appearance	-	-	Occurrence of notable decoloration, deformation and cracking

## Special Notice to Customers Using the Products and Technical Information Shown in This Data Sheet

- 1) The technical information shown in the data sheets are limited to the typical characteristics and circuit examples of the referenced products. It does not constitute the warranting of industrial property nor the granting of any license.
- 2) For the purpose of product improvement, the specifications, characteristics and technical data described in the data sheets are subject to change without prior notice. Therefore it is recommended that the most updated specifications be used in your design.
- 3) When using the products described in the data sheets, please adhere to the maximum ratings for operating voltage, heat dissipation characteristics, and other precautions for use. We are not responsible for any damage which may occur if these specifications are exceeded.
- 4) The products that have been described to this catalog are manufactured so that they will be used for the electrical instrument of the benchmark (OA equipment, telecommunications equipment, AV machine, home appliance and measuring instrument).  
The application of aircrafts, space borne application, transportation equipment, medical equipment and nuclear power control equipment, etc. needs a high reliability and safety, and the breakdown and the wrong operation might influence the life or the human body. Please consult us beforehand if you plan to use our product for the usages of aircrafts, space borne application, transportation equipment, medical equipment and nuclear power control equipment, etc. except OA equipment, telecommunications equipment, AV machine, home appliance and measuring instrument.
- 5) In order to export the products or technologies described in this data sheet which are under the "Foreign Exchange and Foreign Trade Control Law," it is necessary to first obtain an export permit from the Japanese government.
- 6) No part of this data sheet may be reprinted or reproduced without prior written permission from Stanley Electric Co., Ltd.
- 7) The most updated edition of this data sheet can be obtained from the address below:  
<http://www.stanley-components.com>