

Intelligent MP Series

Up to 1500 Watts

Total Power: Up to 1500 Watts

Input Voltage: 85 - 264 Vac
120-300 Vdc

of Outputs: Up to 21

iMP®

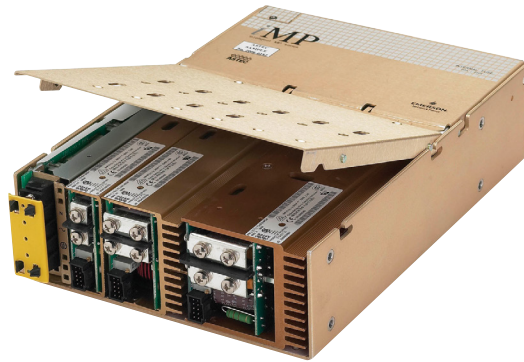

Special Features

- Full Medical EN60601 approval
- Intelligent I²C control
- Voltage adjustment on all outputs (Manual or I²C)
- Configurable input and output (case and module) OK signals and indicators
- Configurable inhibit/enable
- Configurable output UP/DOWN sequencing
- Configurable current limit (foldback or constant current)
- High power density (8.8 W/cu-in)
- Intelligent fan (speed control/fault status)
- Downloadable GUI from website
- Customer provided air option
- uP controlled PFC input with active inrush protection
- I²C monitor of voltage, current, and temp
- Programmable voltage, current limit, inhibit/enable through I²C
- Optional extended hold-up module (SEMI F47 compliance)
- Increased power density to 50% over standard MP
- External switching frequency sync input
- Optional conformal coating
- Industrial temp range (-40 °C to 70 °C)
- No preload required
- Industrial shock/vibration (> 50G's)

Electrical Specifications

Input	
Input range:	85 - 264 Vac 120 - 350 Vdc (limited to 300 Vdc in medical applications)
Frequency:	47 - 440 Hz
Inrush current:	40 A peak max. (soft start)
Efficiency:	Up to 85% @ full case load
Power Factor:	0.99 typ. meets EN61000-3-2 (n/a @ 440 Hz)
Turn-on time:	AC on 2.0 sec typ., inhibit/enable 150 ms typical Programmable delay; 50 ms internal turn-on delay (Dual Output only)
EMI filter:	CISPR 22/EN55022 Level "B"***
Leakage current:	300 µA max. @ 240 Vac; 47 - 63 Hz
Radiated EMI:	CISPR 22/EN55022 Level "B"***
Holdover storage:	20 ms minimum (independent of input Vac) additional 34ms holdover storage with optional HUP module (SEMI F47 compatible). For iMP4 15 ms (low-line), 10 ms (high-line)
AC OK:	> 5 ms early warning min. before outputs lose regulation Full cycle ride thru (50 Hz) (n/a on iMP4 > 750 W @ 90 Vac)
Harmonic distortion:	Meets EN61000-3-2
Isolation:	Meets EN60950 and EN60601
Global Inhibit/Enable:	TTL, Logic "1" and Logic "0"; configurable
Input fuse (internal):	iMP4: 16 A; iMP8: 20 A; iMP1: 25 A (both lines fused)
Warranty:	2 years

Safety

- **UL** UL60950/UL2601**
- **CSA** CSA22.2 No. 234 Level 5
- **VDE** EN60950/EN60601-1**
- **BABT** Compliance to EN60950/EN60601 BS7002
- **CB** Certificate and report
- **CE** Mark to LVD



Output

Adjustment range:*	± 10% minimum all outputs (manual) (full module adjustment range using I ² C)
Factory set point accuracy:	± 1%
I ² C output program accuracy:	± 5%
Margining:	± 4 - 6% nominal analog (single output module only)
Overall regulation:	0.4% or 20 mV max. (1500W modules 1% max.) (36 W modules 4% maximum)
Ripple:	RMS: 0.1% or 10mV, whichever is greater Pk-Pk: 1.0% or 50mV, whichever is greater Bandwidth limited to 20 MHz
Dynamic response:	< 2% or 100 mV, with 25% load step
Recovery time:	To within 1% in < 300 µsec
Overcurrent protection:**	Configurable through I ² C (calibration required). Single output module and main output of the dual output module 105 - 120% of rated output current. Aux output of dual output module 105 - 140% of rated output current
Short-circuit protection:	Protected for continuous short-circuit Recovery is automatic upon removal of short
Overvoltage protection:*	Configurable through I ² C
Single output module:	2 - 5.5 V 122 - 134%; 6 - 60 V 110 - 120%
Dual output module:	2 - 6 V 122 - 134%; 8 - 28 V 110 - 120%
Triple output module:	110 - 120% of highest voltage rating

Output Continued

Reverse voltage protection:	100% of rated output current
Thermal protection:* (OTP and OTW)	Configurable through I ² C All outputs disabled when internal temp exceeds safe operating range. > 5 ms warning (AC OK signal) before shutdown
Remote sense:	Up to 0.5 V total drop (not available on triple output module)
Single wire parallel:	Current share to within 2% of total rated current
DC OK:*	± 5% of nominal. Configurable through I ² C
Minimum load:	Not required
Housekeeping standby:	5 Vdc @ 1.0 A max. present whenever AC input is applied (Optional 2.0 A available)
Module inhibit:*	Configured and controlled through I ² C
Switching frequency:	250k Hz accepts external sync signal
Output/Output isolation:	>1 Megohm, 500 V
External sync:	TTL clock input signal used to adjust switching frequency. Frequency 500 kHz ± 20%; Duty cycle 40 - 55%
* Can be controlled via I ² C	
** Controlled via I ² C but requires load calibration	

Environmental Specifications

Operating temperature:	-40 ° to 70 °C ambient. Derate each output 2.5% per degree from 50 °C to 70 °C. (-20 °C start up)
Storage temperature:	-40 °C to 85 °C
Electromagnetic susceptibility:	Designed to meet EN61000-4; -2, -3, -4, -5, -6, -8, -11 Level 3
Humidity:	Operating; non-condensing 10% to 95% RH
Vibration:	IEC68-2-6 to the levels of IEC721-3-2
MTBF demonstrated	> 550,000 hours at full load, 220 Vac and 25 °C ambient conditions

Output Module Line-up

Module Code	1	2	3	5	4	—
Module Type	Single	Single	Single	Single	Dual	Triple
Max output power	210 W	360 W	750 W	1500 W	144 W	36 W
Max output current	35 A	60 A	150 A	140 A	10 A	2 A
Output voltages available*	2-60 V	2-60 V	2-60 V	6-60 V	8 - 15*, 24 - 28; 8 - 15*, 8 - 15*; 8 - 15*, 2 - 6; 2 - 6, 2 - 6; 24 - 28, 24 - 28; 24 - 28, 2 - 6	8-15, 8-15, 2-6; 8-15, 8-15, 8-15; 8-15, 8-15, 18-28; 8-15, 18-28, 2-6
Standard voltage increments	25	25	25	18	16	18
Remote sense	Yes	Yes	Yes	Yes	Yes	No
Remote margin	Yes	Yes	Yes	Yes	No	No
V-Program - I ² C Control	Yes	Yes	Yes	Yes	Yes	No
Active Current Share	Yes	Yes	Yes	Yes	Yes	No
Module Inhibit - I ² C Control	Yes	Yes	Yes	Yes	Yes	Yes
Module Inhibit - Analog	Yes	Yes	Yes	Yes	Yes	No
Overvoltage/Overcurrent protection	Yes	Yes	Yes	Yes	Yes	Yes
Minimum load required	No	No	No	No	No	No
Slots occupied in any iVS case	1	2	3	4	1	1

* Note: Contact Factory for extended range down to 6 V

Output Module Voltage/Current

Voltage	Voltage Code	Single Output Module Code				Dual Output***		Triple Output			I ² C Adjustment Ranges****
		1	2	3	5 ⁺	4	4	-	-	-	
2 V	A	35 A	60 A	150 A	—	10 A	10 A	—	—	2 A	1.8 - 2.2
2.2 V	B	35 A	60 A	150 A	—	10 A	10 A	—	—	2 A	2.0 - 2.4
3 V	C	35 A	60 A	150 A	—	10 A	10 A	—	—	2 A	2.7 - 3.3
3.3 V	D	35 A	60 A	150 A	—	10 A	10 A	—	—	2 A	3.0 - 3.6
5 V	E	35 A	60 A	150 A	—	10 A	10 A	—	—	2 A	4.5 - 5.5
5.2 V	F	35 A	60 A	144 A	—	10 A	10 A	—	—	2 A	4.7 - 5.7
5.5 V	G	34 A	58 A	136 A	—	10 A	10 A	—	—	2 A	5.0 - 6.1
6.0 V	H	23 A	42 A	97.5 A	140 A	10 A*	10 A*	—	—	2 A	5.4 - 6.6
8.0 V	I	20 A	36 A	84.4 A	140 A	10 A	4 A	1 A	1 A	1 A	7.2 - 8.8
10 V	J	18 A	32 A	75 A	140 A	10 A	4 A	1 A	1 A	1 A	9.0 - 11.0
11 V	K	17 A	31 A	68 A	136.3 A	10 A	4 A	1 A	1 A	1 A	9.9 - 12.1
12 V	L	17 A	30 A	62.5 A	125 A	10 A	4 A	1 A	1 A	1 A	10.8 - 13.2
14 V	M	14 A	21 A	53.5 A	107 A	9 A	4 A	1 A	1 A	1 A	12.6 - 15.4
15 V	N	14 A	20 A	50 A	100 A	8 A	4 A	1 A	1 A	1 A	13.5 - 16.5
18 V	O	11 A	19 A	41.6 A	83.3 A	—	—	—	0.5 A	0.5 A	16.2 - 19.8
20 V	P	10.5 A	18 A	37.5 A	75 A	—	—	—	0.5 A	0.5 A	18.0 - 22.0
24 V	Q	8.5 A	15 A	30 A	62.5 A	4 A	2 A	—	0.5 A	0.5 A	21.6 - 26.4
28 V	R	6.7 A	11 A	26.8 A	53.5 A	3 A	2 A	—	0.5 A	0.5 A	25.2 - 30.8
30 V	S	6.5 A	11 A	25 A	50 A	—	—	—	—	—	27.0 - 33.0
33 V	T	6.2 A	10.9 A	22.7 A	35.8 A	—	—	—	—	—	29.7 - 36.3
36 V	U	5.8 A	10 A	20.8 A	35.8 A	—	—	—	—	—	32.4 - 39.6
42 V	V	4.2 A	7.5 A	16 A	35.7 A	—	—	—	—	—	37.8 - 46.2
48 V	W	4.0 A	7.5 A	15.6 A	31.2 A	—	—	—	—	—	43.2 - 52.8
54 V	X	3.7 A	6.0 A	13.9 A	27.7 A	—	—	—	—	—	48.6 - 59.4
60 V	Y	3.5 A	6.0 A	12.5 A	25 A	—	—	—	—	—	54.0 - 66.0

Non-std** Z Special Voltage - Consult Factory for specifications

*Note: Contact Factory for extended range down to 6 V.

**Increments of current not shown can be achieved by paralleling modules (add currents of each module selected).

***Total output power on dual module must not exceed 144 W.

**** For single output modules only.

+ Applicable for iMP1 only.

Ordering Note:

- The cases and modules of both MP and iMP series can be interchanged to allow more flexibility. If intelligent modules are used with non-intelligent cases, a numeric code "4" is placed at the end of the module code (ex. 4LL0 becomes 4LL4).
- USB to I²C module order code 73-769-001

Parallel Codes

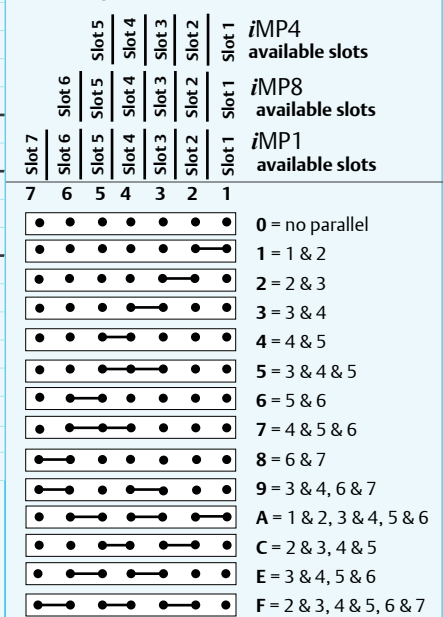

Ordering Information

Case Size	Module/Voltage/Option Codes	Case Option Codes	Software Code	Hardware Code
<p>iMP1*</p> <p>Case Size (mm) 4 = 2.5" x 5" x 10"; 750 W-1158 W, 5 Slots (63.5 x 127 x 254) 8 = 2.5" x 7" x 10"; 1000 W-1200 W, 6 Slots (63.5 x 177.8 x 254) 1 = 2.5" x 8" x 11"; 1200 W-1500 W, 7 Slots (63.5 x 203.2 x 279.4)</p> <p>*Note: Add "E" after iMP4 to denote IEC input option. e.g. iMP4E (Not available on iMP8 or iMP1)</p>	<p>First - Module Code Second - Voltage Code Third - Option Code</p> <p>3L0 - 2E2 - 1Q1 - 4LL0</p> <p>Module Codes Module/voltage/option codes Module codes: (None) = 36 W triple O/P (1 slot) 1 = 210 W single O/P (1 slot) 2 = 360 W single O/P (2 slot) 3 = 750 W single O/P (3 slot) 4 = 144 W dual O/P (1 slot) 5 = 1500 W single O/P (4 slot) 6 - 9 = future</p> <p>Voltage Codes: See Output Module Voltage/Current table above</p> <p>Option Codes: 0 = Standard 1 = Module enable 2 = Constant current 3 = 1 & 2 combined 4 = Set for use in standard (non-intelligent case) 5 = Shutdown mode for 1500W 6 = 1 & 5 combined 7 - 9 = future</p>	<p>00</p> <p>Case Option Codes</p> <p>First digit 0 - 9, A-Z parallel code (See Parallel Codes table above)</p> <p>Second digit 0 = No options 1 = Reverse air 3 = Global enable 4 = Fan idle with inhibit 5 = Opt 1 + Opt 3 6 = Opt 1 + Opt 4 7 = Opt 3 + Opt 4 8 = Opt 1 + 3 + 4 9 = CAN BUS/RS485 73-544-002 C = Opt 3 + Opt 9</p>	<p>A</p> <p>Software code used for configuration change. "A" is standard</p>	<p>###</p> <p>Factory assembled for hardware of firmware mods.</p>

Single



210 W

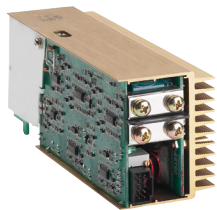

360 W

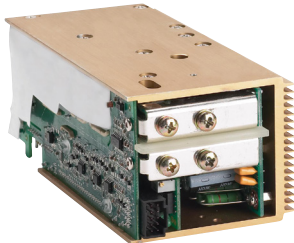

750 W



1500 W

Dual

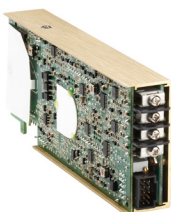

144 W

Triple



36 W

iMP4 (AC input on opposite side)

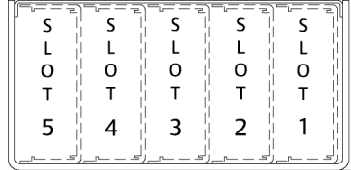

iMP4 = 2.5" x 5" x 10" 5 available slots
(63.5 x 127 x 254)

Input	
90-264 Vac	180-264 Vac
750 W max.	1158 W max.

iMP8 and iMP1

AC input

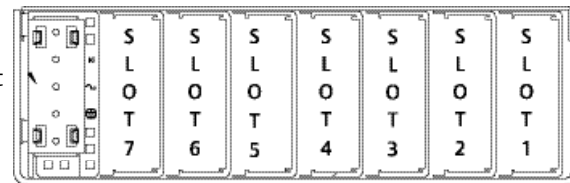

iMP1 only

iMP8 = 2.5" x 7" x 10" 6 available slots
(63.5 x 177.8 x 254mm)

Input	
85-264 Vac	180-264 Vac
1000 W max.	1200 W max.

iMP1 = 2.5" x 8" x 11" 7 available slots
(63.5 x 203.2 x 279.4mm)

1200 W max.	1500 W max.
-------------	-------------

Pin Connectors

Figure 1. AC Input

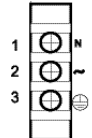

AC Input

Pin No.	Function
1	AC neutral
2	AC line (hot)
3	Chassis (earth) ground

Figure 2. Connector J1

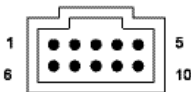

Mates with
Molex 90142-0010 Housing
90119-2110 Pin
Connector Kit Part No.:
70-841-004

PFC Input Connector (control and signals)

Pin No.	Function
1	Input AC OK - "emitter"
2	Input AC OK - "collector"
3	Global DC OK - "emitter"
4	Global DC OK - "collector"
5	External Sync
6	Global inhibit/optional enable logic "0"
7	Global inhibit/optional enable logic "1"
8	Global inhibit/optional enable return
9	+5 VSB housekeeping
10	+5 VSB housekeeping return

Figure 3. Connector J2

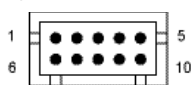

Mates with
Landwin 2050S1000 Housing
2053T011V Pin
or
JST PHDR-10VS Housing
JST SPHD-002T-P0.5 (28-24)
JST SPHD-001T-P0.5 (26-22)

PC Bus Output Connector

Pin No.	Function
1	No connection
2	No connection
3	No connection
4	Serial clock signal (SCL)
5	Serial data signal (SDA)
6	Address bit 0 (A0)
7	Address bit 1 (A1)
8	Address bit 2 (A2)
9	Secondary return (GND)
10	5 Vcc external bus (5 VCC. Bus)

Connector Kit Part No.:
70-841-023

iMP Modules

DC-DC Converter Output Modules

Control Signal Information, J1 Control Connector

Pin No.	Function	
1	+ Remote Sense	single or dual o/p main
2	Remote Margin / V. Program	single o/p
3	Margin High	single o/p
4	- Remote Sense / Margin Low	single or dual o/p main
5	Spare	
6	Module, Isolated Inhibit	single or dual o/p
7	Module Inhibit return	single or dual o/p
8	Current Share (SWP)	single or dual o/p main
9	+ Remote Sense V2	dual o/p, single is spare
10	- Remote Sense V2	dual o/p, single is spare

*Note: All iMP modules have a green DCOK LED.
(except for 36 W module)

Figure 4. Connector J1

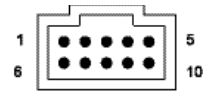

Mates with
Molex 90142-0010 Housing
90119-2110 Pin

Single 210 Watt

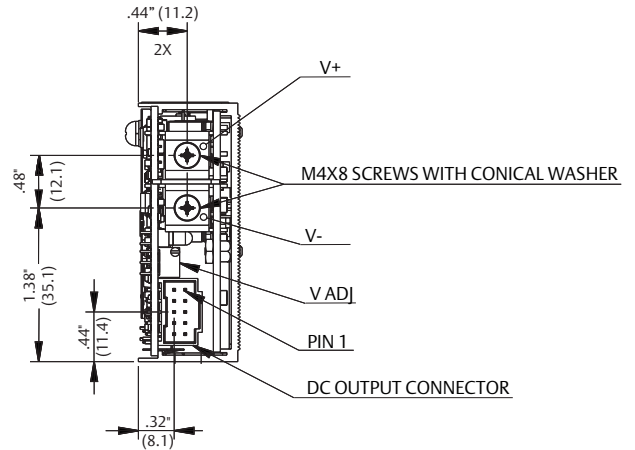

Single 360 Watt

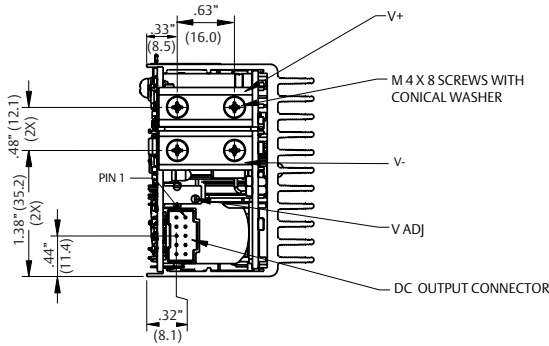

Single 750 Watt

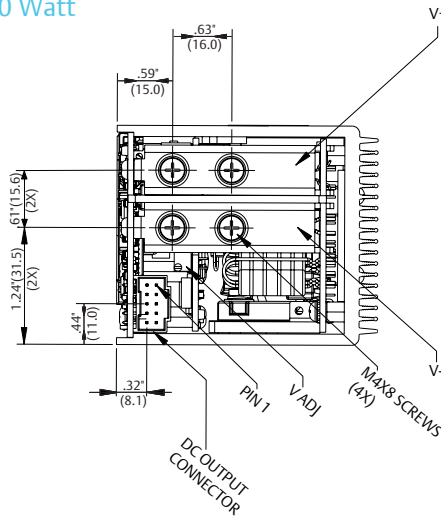

Single 1500 Watt

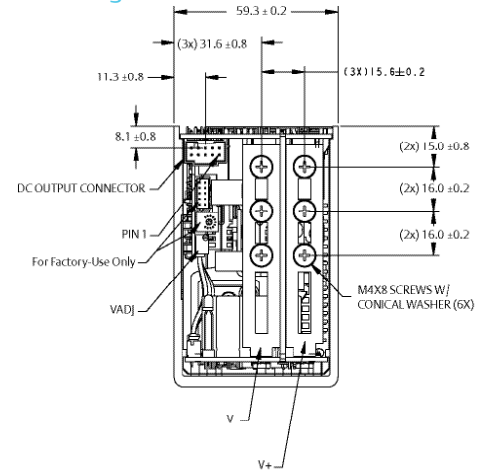

Dual 144 Watt

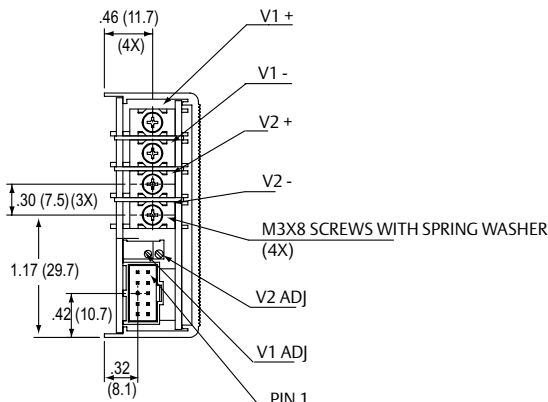

Triple 36 Watt

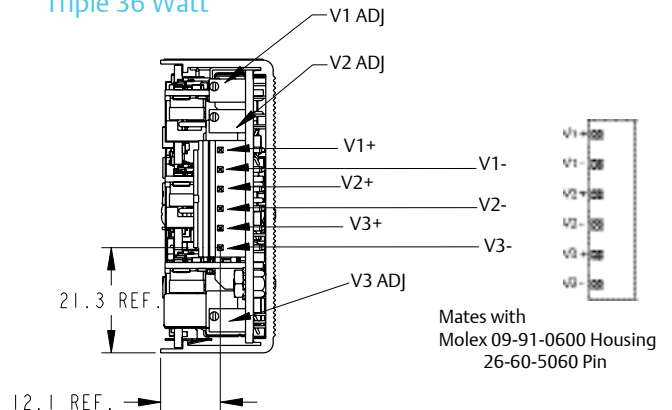

iMP Series
iMP4 (750/1158 Watts Max)

5-Inch Case Size: iMP4: 2.5" x 5" x 10" (63.5mm x 127mm x 254mm)
Weight: iMP4 Case: 3 lbs. • 360 W Single 1.0 lb.
• 750 W Single: 1.6 lbs. 144 W Dual: 0.6 lb.

Rev.01.09.13_78
iMP Series
6 of 9

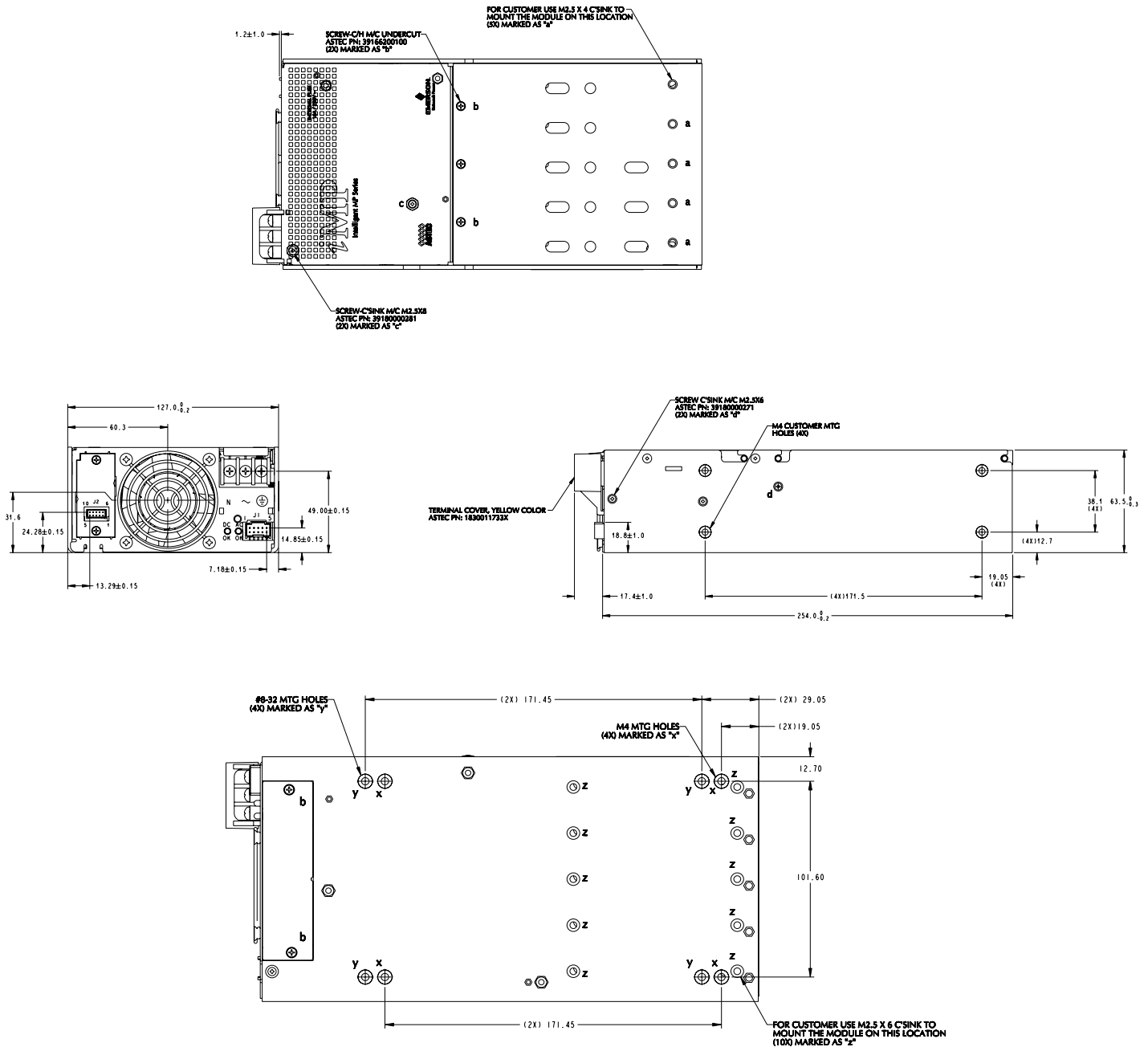

Notes

1. Input: Barrier type. Three No. 6-32 B.H. screws (0.375" centers). Max torque: 6 in-lbs. (0.67 N-m). (Optional IEC input connector)
2. Control connectors: (J1) 10 position housing, gold plated contacts. Mates with Molex 90142-0010 housing with 90119-2110 crimp contacts (Molex C - Grid III Series). Connector kit includes mating connector and 10 pins, Astec part #70-841-004. (J2) 10 position housing (Landwin 2051P1000T). Mates with housing 2050S1000 (Landwin) with 2053T011P (Landwin) pins or JST PHDR-IOVS Housing and JST SPHD-002T-PO.5 pins.
3. Chassis material: aluminum with chemical film coating (conductive).
4. All dimensions are in millimeters and inches, and are typical.
5. Customer mounting -3 sides M4, bottom also includes 8-32 mounting holes. Max. penetration is 0.150" (3.8 mm). Max. torque: 5 in-lbs. (0.57 N-m).
6. Output module connections: All single O/P modules are M4 x 8mm screws. Max. torque: 10 in-lbs. (1.13 N-m). Dual O/P module is M3 x 8mm screws. Max. torque: 5 in-lbs. (0.57 N-m).

iMP Series
iMP8 (1000/1200 Watts Max)

7-Inch Case Size: iMP8: 2.5" x 7" x 10" (63.5mm x 177.8mm x 254mm)
Weight: iMP8 Case: 4.1 lbs. • 210 W Single: 0.6 lb. • 360 W Single: 1.0 lb.
• 750 W Single: 1.6 lbs. 144 W Dual: 0.6 lb.

Rev.01.09.13_78
iMP Series
7 of 9

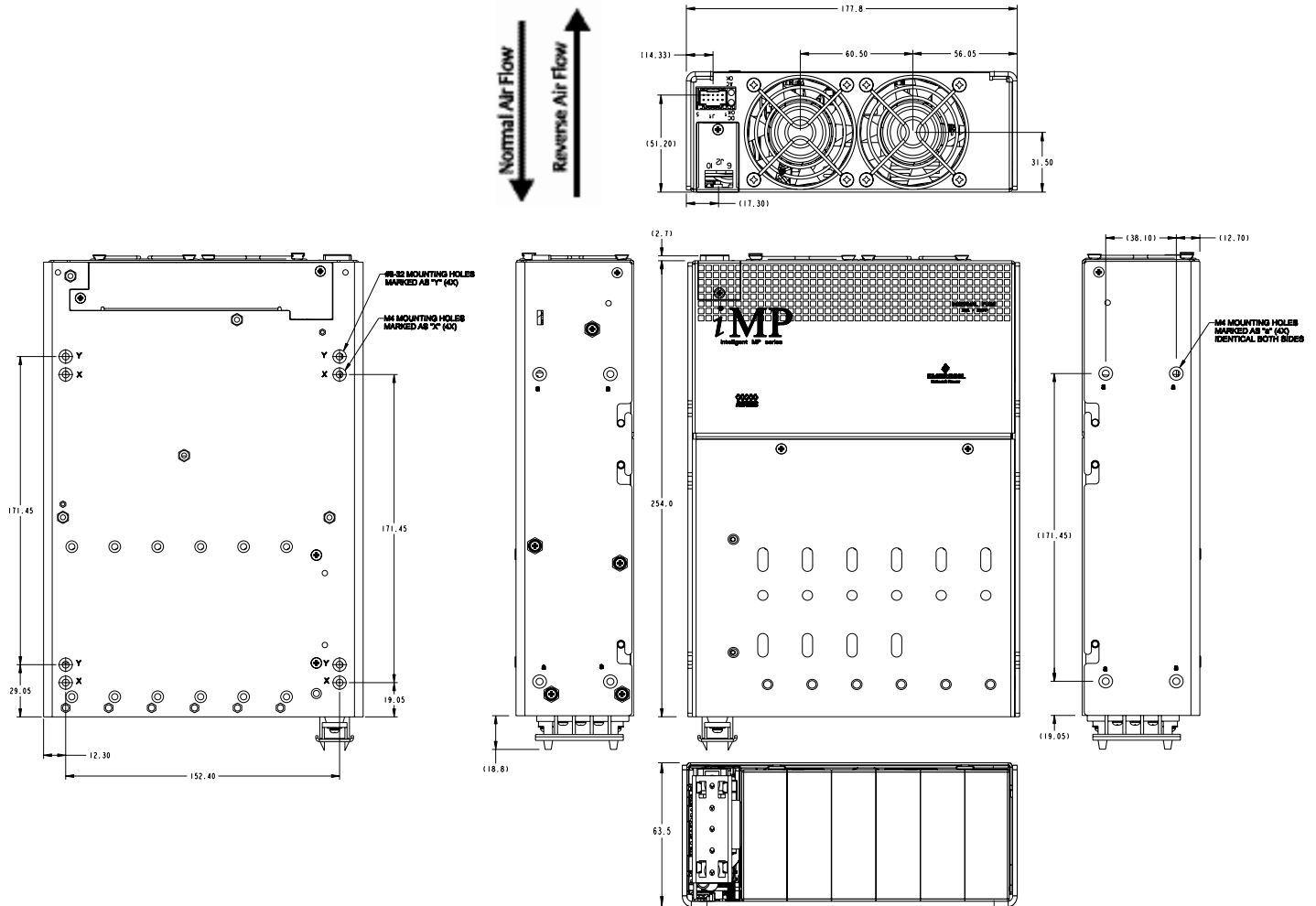

Notes

1. Input: Barrier type. Three No. 6-32 B.H. screws (0.375" centers). Max torque: 6 in-lbs. (0.67 N-m).
2. Control connectors: (J1) 10 position housing, gold plated contacts. Mates with Molex 90142-0010 housing with 90119-2110 crimp contacts (Molex C - Grid III Series) Connector kit includes mating connector and 10 pins, Astec part #70-841-004. (J2) 10 position housing (Landwin 2051P1000T). Mates with housing 2050S1000 (Landwin) with 2053T011P (Landwin) pins or JST PHDR-IOVS Housing and JST SPHD-002T-PO.5 pins.
3. Chassis material: aluminum with chemical film coating (conductive).
4. All dimensions are in millimeters and inches, and are typical.
5. Customer mounting -3 sides M4, bottom also includes 8-32 mounting holes. Max. penetration is 0.150" (3.8 mm). Max. torque: 5 in-lbs. (0.57 N-m).
6. Output O/P module connections: All single O/P modules are M4 x 8mm screws. Max. torque: 10 in-lbs. (1.13 N-m).
Dual O/P module is M3 x 8mm screws. Max. torque: 5 in-lbs. (0.57 N-m).

iMP Series
iMP1 (1200/1500 Watts Max)

8-Inch Case Size: iMP1: 2.5" x 8" x 11" (63.5mm x 203.2mm x 279.4mm)
Weight: iMP1 Case: 5.0 lb. • 210 W Single: 0.6 lb.
• 360 W Single: 1.0 lb. • 750 W Single: 1.6 lb.
• 144 W Dual: 0.6 lb.

Rev.01.09.13_78
iMP Series
8 of 9

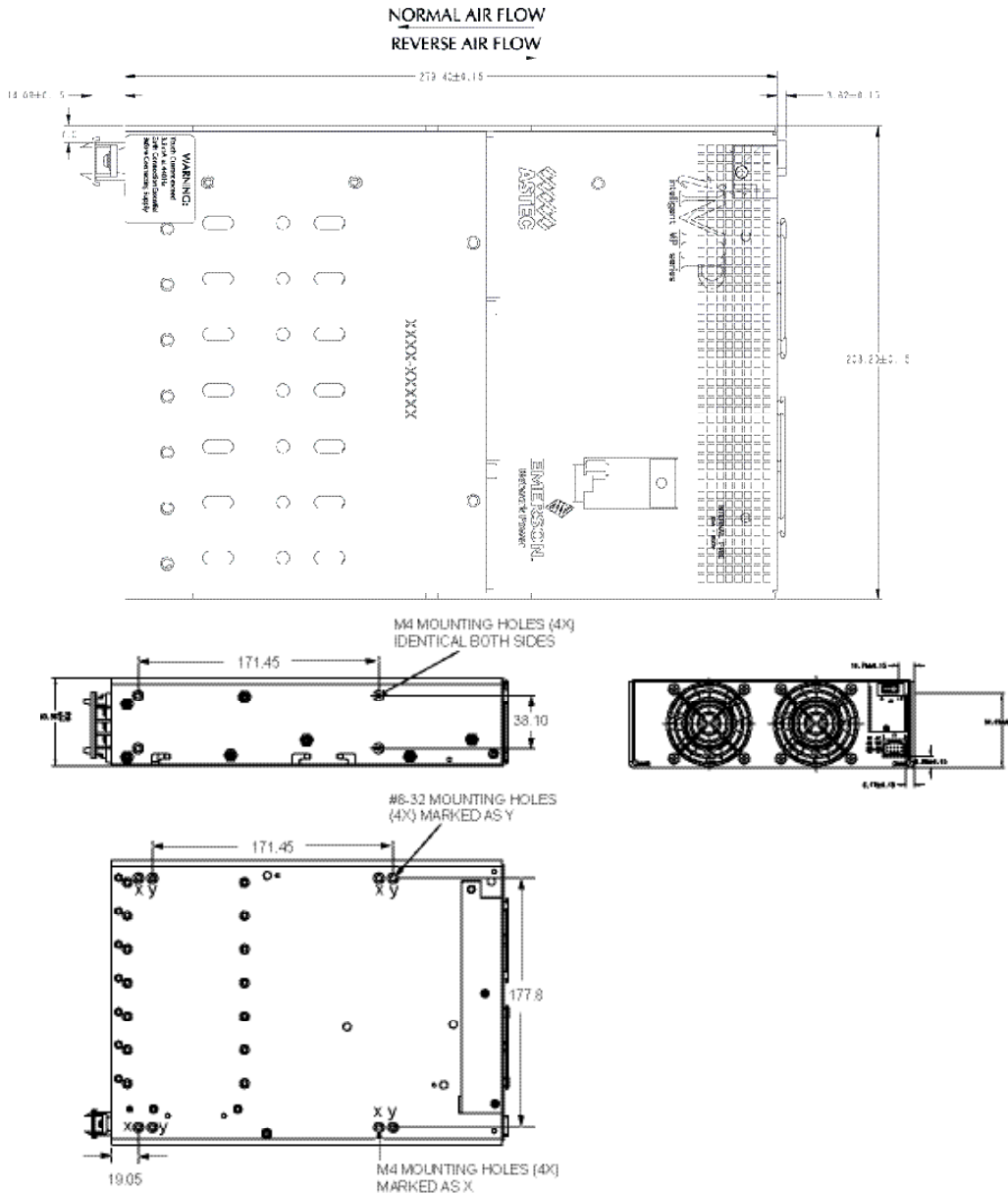

Notes

1. Input: Barrier type. Three No. 6-32 B.H. screws (0.375" centers). Max torque: 6 in-lbs (0.67 N-m).
2. Control connectors: (J1) 10 position housing, gold plated contacts. Mates with Molex 90142-0010 housing with 90119-2110 crimp contacts (Molex C - Grid III Series). Connector kit includes mating connector and 10 pins, Astec part #70-841-004. (J2) 10 position housing (Landwin 2051P1000T). Mates with housing 2050S1000 (Landwin) with 2053T011P (Landwin) pins or JST PHDR-IOVS Housing and JST SPHD-002T-PO.5 pins.
3. Chassis material: aluminum with chemical film coating (conductive).
4. All dimensions are in millimeters and inches, and are typical.
5. Customer mounting -3 sides M4, bottom also includes 8-32 mounting holes. Max. penetration is 0.150" (3.8 mm). Max. torque: 5 in-lbs. (0.57 N-m).
6. Output module connections: All single O/P modules are M4 x 8mm screws. Max. torque: 10 in-lbs. (1.13 N-m). Dual O/P module is M3 x 8mm screws. Max. torque: 5 in-lbs. (0.57 N-m).

Optional CANBUS or RS485 Interface

The RS485/CAN-to-I²C uses 2 Input Protocols and 1 Output Protocol.

The Input Protocols used are RS485 using Modbus (Command Index: 0x01), and CAN using modified Modus (Command Index: 0x02).

The Output Protocol use is: I²C with SMBus support (Command Index: 0x80).

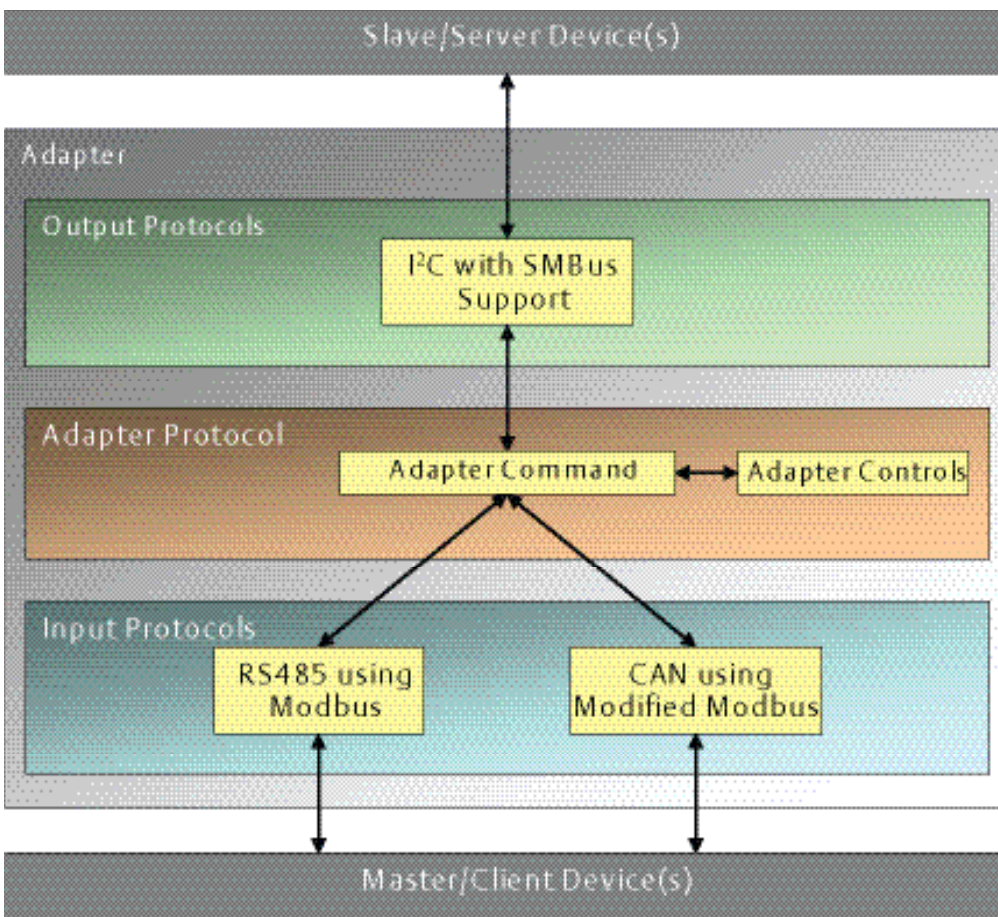

RS485/CAN - to - I2C

For Detailed Info, Download the Software Requirements Specification (SRS) from www.PowerConversion.com/imp

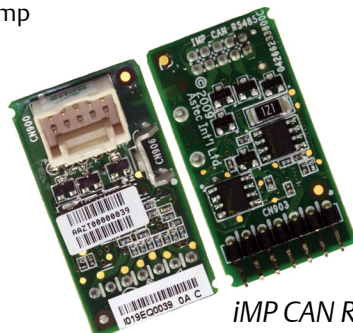

iMP CAN RS485

Americas

5810 Van Allen Way
Carlsbad, CA 92008
USA
Telephone: +1 760 930 4600
Facsimile: +1 760 930 0698

Europe (UK)

Waterfront Business Park
Merry Hill, Dudley
West Midlands, DY5 1LX
United Kingdom
Telephone: +44 (0) 1384 842 211
Facsimile: +44 (0) 1384 843 355

Asia (HK)

14/F, Lu Plaza
2 Wing Yip Street
Kwun Tong, Kowloon
Hong Kong
Telephone: +852 2176 3333
Facsimile: +852 2176 3888

For global contact, visit:

www.Emerson.com/EmbeddedPower
techsupport.embeddedpower@emerson.com

While every precaution has been taken to ensure accuracy and completeness in this literature, Emerson Network Power assumes no responsibility, and disclaims all liability for damages resulting from use of this information or for any errors or omissions.

Emerson Network Power.
The global leader in enabling business-critical continuity.

- AC Power
- Connectivity
- DC Power
- Embedded Computing
- **Embedded Power**
- Monitoring
- Outside Plant
- Power Switching & Controls
- Precision Cooling
- Racks & Integrated Cabinets
- Services
- Surge Protection

EmersonNetworkPower.com

Emerson and the Emerson Network Power logo are trademarks of Emerson Electric Co. ©2012 Emerson Electric Co. All rights reserved.