

Reference Design # 0618

IRAC1166-100W

+16V Low-side Smart Rectification
100W Flyback Demo Board
User's Guide

by

ISRAEL SERRANO

18 August 2006

	Page(s)
Table of Contents	2
1.0 INTRODUCTION	3
2.0 GENERAL DESCRIPTION	3
2.1 IRAC1166-100W +16V Demo Board Schematic Diagram	4
2.2 IRAC1166-100W +16V Demo Board Pictures	5
2.3 IRAC1166-100W +16V Demo Board PCB Layout	6
3.0 Circuit Description	7
4.0 Test Connection and Set up Pictures	8
5.0 Circuit Features	9
5.1 OVT Setting	9
5.2 ENABLE Setting	9
5.3 MOT Setting	9
5.4 Mosfet Selection Design Tips	10
6.0 Test Waveforms	11-18
6.1.1 Transient Load Test	11-13
6.1.2 Static Load Test	14-15
6.1.3 Ripple And Noise Measurement	16
6.1.4 Dynamic load Test	17
6.4 Startup & UVLO Test	18
7.0 Line / Load Regulation Test	19
7.1 IR1166 Demo Board V-I Characteristics Curve	19
7.2 System Efficiency Test	20
7.3 Thermal Verification	20
8.0 Summary	21
9.0 Appendix	21-25
9.1 Transformer turns ratio, Duty Cycle and Secondary Current Relationship Chart	21
9.2 IR1166 100W +16V SR Demo Board Power Transformer Specs	22
10.0 IRAC1166-100W +16V Demo Board Bill of Materials (BOM)	23-24

1.0 INTRODUCTION

Generally, Schottky diodes are traditional devices use in passive rectification in order to have low conduction loss in secondary side for switching power supplies. The proliferations of synchronous rectification (SR) idea - which is mostly use in buck-derive topologies - have reached the domain of flyback application in recent years. The use of low-voltage-low-Rdson mosfet has become so attractive to replace the Schottky rectifiers in high current applications because it offers several system advantages such as dramatic decrease in conduction loss and better thermal management of the whole system by reducing the cost investment in heat sink and PCB space.

A number of techniques in the implementation of SR in flyback converters are continuously growing from a simple self-driven (secondary winding voltage detection) to a more complex solution using "current transformer sensing" or combinations of both to improve the existing technology. The idea has become quite complicated though and additional discrete devices have made the cost and part counts issue even worse. Moreover, the issue of reverse current conduction (-due to the delay in sensing the sharp drop of secondary current during turn-off phase of the SR) still lingers on in different input line/ output load conditions. The use of a simple fast-rate-direct-sensing of voltage drop across the mosfet (Vsd) using integrated solution has pave the way for a much simpler and effective means of controlling the SR mosfets as well as alleviating the reverse current and multiple-pulse gate turn-ON issues.

The objective of this user guide is to show the advantages of SR application using integrated IC approach and study the practical limits of the efficiency improvements vs. the normal rectification method.

2.0 GENERAL DESCRIPTION

The IRAC1166-100W demo board is a universal-input flyback converter with single DC output capable of delivering continuous 100W (@ +16V x 6.25A) during active rectification mode. This demo board is primarily designed to study synchronous rectification using IR1166 in low-side configuration to take advantage of simpler derivation of Vcc supply from converter's output. It is equipped with necessary jumpers to ease exploring the conduction behavior of synchronous rectifiers SRs in quasi-resonant mode, so discussion would be confined to variable frequency switching in Critical Conduction Mode.

It features the fast Vsd sensing of the IR1166 Smart Rectifier Control IC with gate output drive capability of 1.5Apk. It drives 2 pcs. of SRs in parallel (100V N-ch mosfet IRF7853 in SO-8 package with very low Rdson in its class : 18 mΩ max). This had greatly simplified the overall mechanical design for not having those bulky and heavy heat sinks normally seen in high current flyback design using passive rectification.

FIGURE 1. IRAC1166-100W SCHEMATIC DIAGRAM

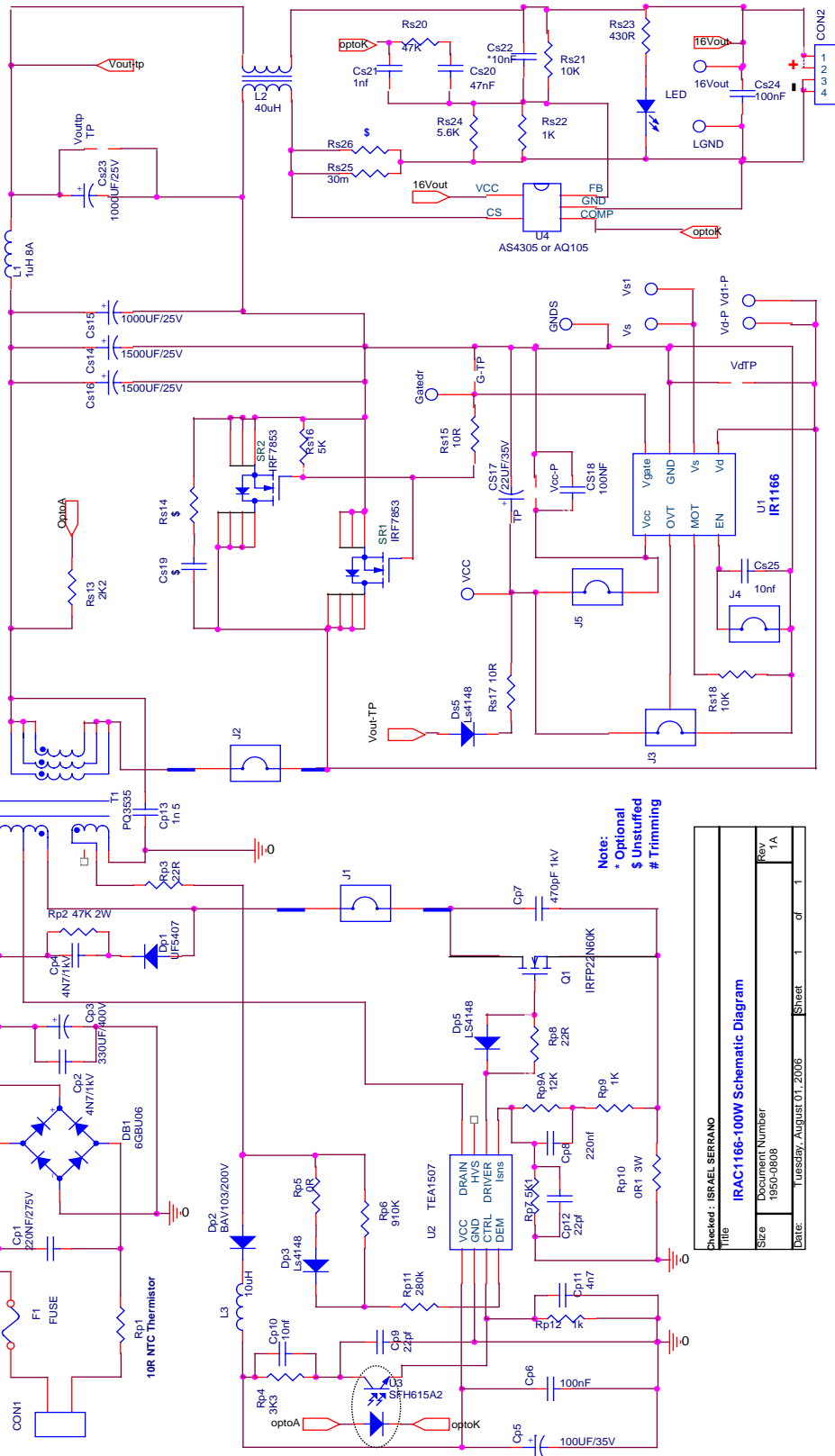

Note:
* Optional
\$ Unstuffed
Trimming

Checked: ISRAEL SERRANO
Title: IRAC1166-100W Schematic Diagram
Size: 1850-0808
Document Number: 1850-0808
Date: Tuesday, August 01, 2006
Sheet: 1 of 1

2.1 IRAC1166-100W Demo Board Pictures

Figure 2A. Top side of the IRAC1166-100W Demo Board



Figure 2B. Bottom side of the IRAC1166-100W Demo Board

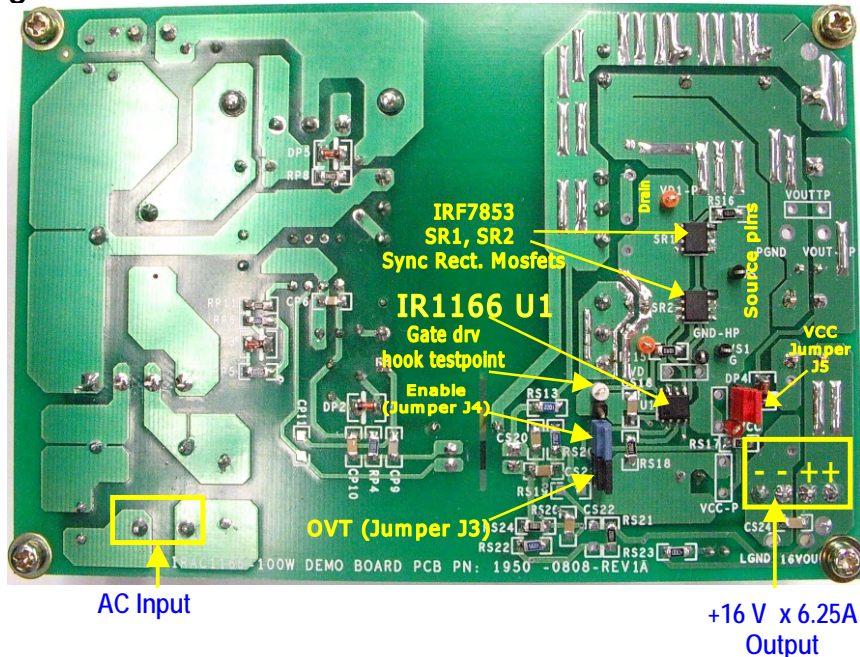

2.2 PCB Layout for IRAC1166-100W

Figure 3A. Top layer etch with silkscreen print

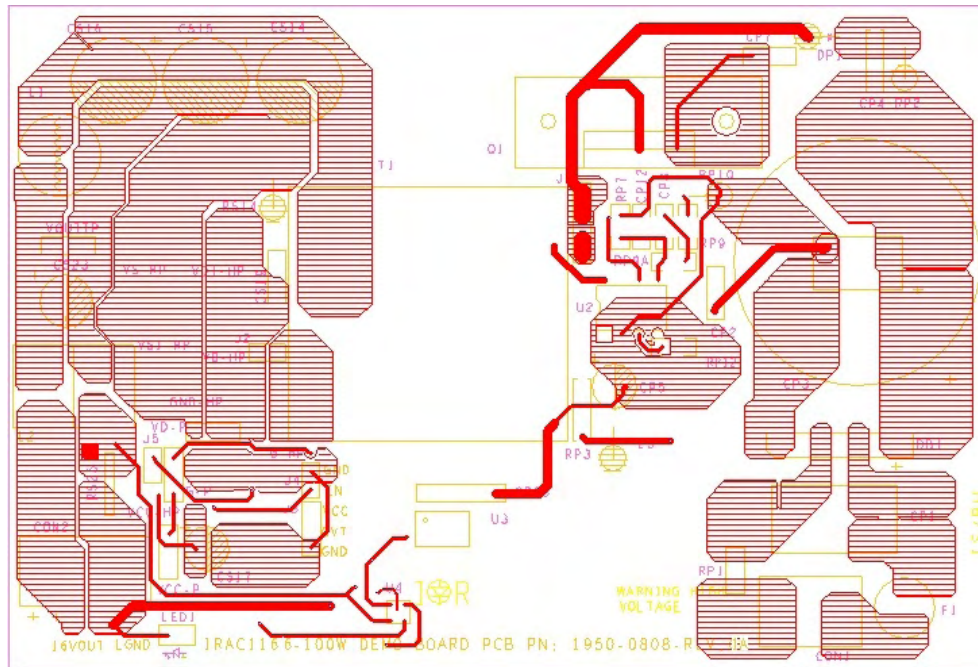
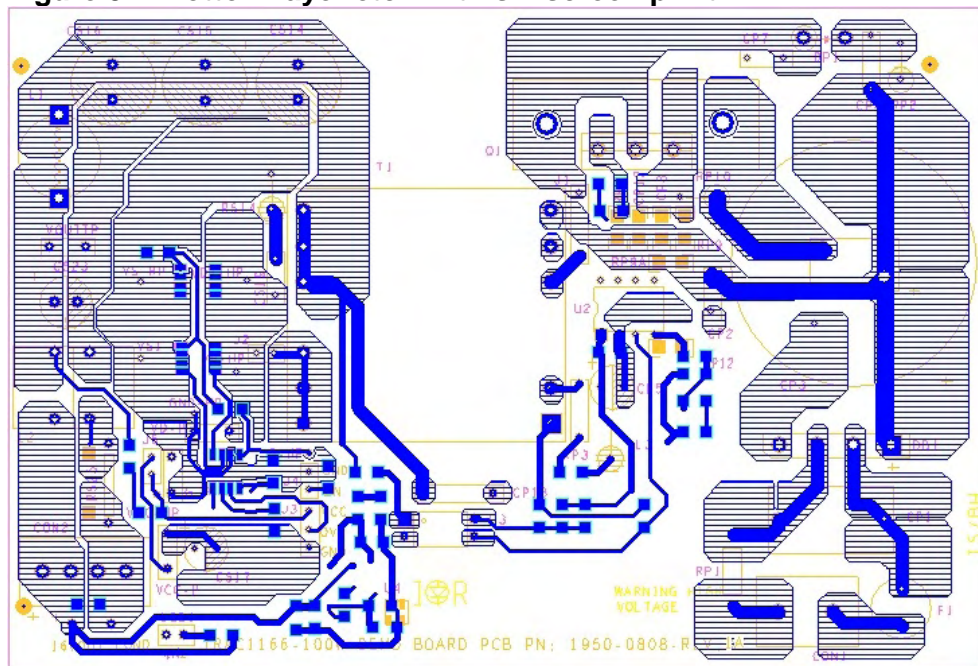

Figure 3B. Bottom layer etch with silkscreen print.



3.0 CIRCUIT DESCRIPTION

The PCB design is basically optimized as a test platform to evaluate of active rectification using Smart synchronous rectification and as well as basic features of flyback converter operating in quasi-resonant mode.

This demo board has 2-pin connector (CON1) for AC input and a time-lag type 3.5A fuse for input current overload protection. Minimum input filtering is provided (Cp1-Xcap) before AC input voltage (90-264VAC) is routed to a 6Amp-bridge rectifier (DB1).

Primary side controller (U2) basically drives the primary Mosfet Q1 to operate in Critical-Conduction mode to eliminate turn-ON switching loss thru ZVS (zero voltage switching only occurs when $nV_{sec} > V_{dcin}$) or thru LVS (low-voltage switching when $nV_{sec} < V_{dcin}$) to reduce capacitive losses of Q1 especially at high line condition. The switching frequency F_{sw} at full load varies from ~38 to ~76kHz typically from low to high input condition and falls back to minimum value (fixed ~ 6 -10kHz) to reduce input power during light load condition.

Auxiliary winding is loosely monitored by demagnetization pin4 of U2 through Dp3, Rp5 and Rp11 network that sets the OVP limit with Rp6 and Rp11 sets the over power limit of the converter.

Resonant capacitor Cp7 is added to augment the overall parasitic winding capacitance and the primary mosfet Q1's Coss to achieve ZVS and LVS at low and high input line condition respectively.

Optocoupler U3 provides isolated output voltage feedback to the primary side. The output voltage level across load connector CON2 (+16Vo) is monitored and regulated by the V/I Secondary error amplifier U4 (AQ105 or AS4305) that also manages the output current limiting function by monitoring the voltage across the RS25-26 current sense resistors.

The power stage of the secondary is using 2-SO8 low IRF7853 synch-fets (SR) in parallel to implement the low-side synchronous rectification. In this configuration, it is simpler to derive the Vcc supply for the U1 (IR1166 SO8-IC) controller directly from the DC output Vout. Jumper J5 is used to isolate U1's Vcc from Vout so that user may easily evaluate IC's power consumption especially during standby load condition. In the absence of a sensitive low current probe, the quiescent current Icc through Dp4 can be calculated from the differential voltage across the Rs17. The decoupling capacitor Cs17 and Cs18 provides additional filtering which is necessary to clean high frequency noise especially when U1 is driving several mosfets (SR1 // SR2) with high Qg parameters normally associated with high current-low voltage mosfets.

The Vd and Vs sense pins monitor the voltage (Vsd) across the sync rect mosfets and proper attention was taken during PCB routing to ensure the integrity of differential voltage Vsd. This is done by directly taking the signal Vd from the drain pins of SR1//SR2 using a dedicated trace.

Probe points as well as redundant test hook points are provided to facilitate easy probing of essential test waveforms.

4.0 TEST CONNECTION AND SETUP DIAGRAM

4.1 Recommended setup for Voltage and Current probing



Fig. 4A Direct gate voltage probing using tip & gnd spring.



Fig. 4C Connecting O-scope probe to hook Gate drive test points.



Fig. 4B Recommended probing of secondary current waveform.



Fig. 4D Recommended probing of Vout's Ripple & Noise voltage.

5.0 CIRCUIT FEATURES

5.1 OVT setting:

The Offset Voltage Threshold can be easily selected by changing the position of jumper J3 according to system mode of operation as shown on Table 1 below. Since the demo board is practically designed to operate in **Critical conduction mode**, OVT pin can be left floating or grounded to prolong the MOSFET's channel conduction period a bit compared to connecting it to Vcc. As a result, this would give the advantage of further reducing the conduction period of the MOSFET's (SR1 & SR2) body diode, thus achieving more efficient operation. Reducing the chance of having reverse current during the fast turn-off phase of the sync-fets is another strong reason for having this feature available.

Table 1

System mode of operation	OVT connected to
DCM or CrCM	Ground, $V_{TH1} = -3.5\text{mV}$
Boundary CCM	Floating, $V_{TH1} = -10.5\text{mV}$
CCM	V_{CC} , $V_{TH1} = -19.0\text{ mV}$

The general observation during light load condition (~10-20% full load) is that a ~0.5 to ~1.2% efficiency improvement was seen for OVT=Gnd compared to OVT=floating. This small difference is no longer significant when the load becomes heavy for CrCM operation.

5.2 Enable setting:

The IC is enabled by default knowing that EN pin is tied internally to VCC through a resistor. Having a jumper on J4 location will connect EN pin to Gnd and will immediately disable the internal gate drive circuit of the IR1166 IC. By putting a jumper J4 in/out would help the user to quickly evaluate the effect in efficiency by investigating the change in input power as a result of having SR fets working compared to just having an ordinary passive rectification offered by the body diode(s) when the gate drive is disabled.

CAUTION :

This demo board is basically designed for evaluation of functionality of IR1166 IC. The users may disable the IC by shorting J4 EN to GND for quick testing at full load but with care should be taken. It is strongly advise not to load more than 4.6 - 6Amp with IR1166 disabled for a prolong period of time (>1min). This is to prevent damaging the MOSFET's body diode due to overheating when the load current passes through the mosfets' body diode while SRs are turned-OFF. Never power-up the unit without shorting J5.

5.3 Minimum ON Time (MOT) setting:

MOT setting is used to de-sensitize the IC from multiple change in Vsd during the turn-ON phase of SRs which is cause by the ringing of the secondary winding voltage (Vsec). MOT can be adjusted through Rs18 (according to AN1087 simplified equation $R_{MOT} = 2.5 \times 10^{10} * t_{mot}$) and is chosen to be 400 ns which is usually enough to ignore the parasitic noises at Vsd in a quasi-resonant switching converters such as this demo board.

5.4 Mosfet Selection Design Tips

Application note AN1087 has made it easy to understand the calculations required in flyback sync-rect driving circuits using IR1166 IC. Choosing the right mosfet(s) to satisfy the performance–cost requirement of any sync rect design should be simple as well.

Voltage rating:

SRs should also follow similar equation in most flyback design as shown below:

$V_{sd} > k * [V_o + (V_{DCin_{max}} / (N_{pri}/N_{sec}))]$ where $k = 1.1$ to 1.4 as a guard band for startup stress due to leakage spike.

Rds_{ON} rating:

Generally, it is easy to meet >1% system efficiency improvement if the conduction loss of the SRs becomes twice smaller than normal passive rectification approach. This is to achieve better thermal performance especially if the designer wishes to consider not having too bulky and heavy heatsink in the design, but take note that it would still be largely dependent on the size PCB copper area allotted to the SRs. We should also consider the estimated Rds_{ON} at 25°C (normally shown in the datasheet) would be approximately ~1.8 times higher at T_j=125°C. As a rule of thumb, we will base our calculation on these assumptions to simplify the mosfet selection criteria.

For typical 100V Schottky rectifiers, V_f is around ~ 600 mV (@T_j=125°C), so in this case we should find a 100-V mosfet(s) with lower Rds_{ON} which will have a ~150mV max Vsd at rated full load current (I_{o_ave}). For quick estimation of I_{sec_rms}, designer might find Fig. 9.1 useful to quickly estimate I_{sec_rms} since I_{o_ave} is normally given as standard design specs.

Calculating the rms value of secondary current is easier for CrCM mode where

$$D = N * V_{sec} / (N * V_{sec} + V_{dcin_{min}}) \quad \text{eqn. 1}$$

$$N = N_{pri} / N_{sec}, \quad N = 31/5$$

Let V_{sec} = 16.1, V_{dcmin} = 100, D = ~50%

$$h = V_f (\text{Schottkydiode}) / V_{sd}(\text{mosfet}) \quad \text{eqn. 2}$$

$$P_{dis SR} < 1/h * V_{fdiode} * I_{o_ave} \quad \text{eqn. 3}$$

With $h > 2$,

$$\text{Target } V_{SD(@T_j=125^\circ C)} \leq 600mV / 2$$

$$\leq \underline{300mV}$$

$$I_{sec_{rms}}^2 * R_{dsON}(@T_j=125^\circ C) \leq 300 mV * I_{o_ave} \quad \text{eqn. 4}$$

$$R_{dsON}(@T_j=125^\circ C) = \sim 1.8 * R_{dsON}(@T_j=25^\circ C) \quad \text{eqn. 5}$$

$$I_{sec_{rms}} = \frac{2I_{o_ave} \sqrt{(1-D)/3}}{(1-D)} \quad \text{eqn. 6}$$

Combining equations 4, 5, and 6

$$R_{dsON} @ T_j=25^\circ C \leq \frac{166mV [3(1-D)]}{4I_{o_ave}} \quad \text{eqn. 7}$$

$$R_{dsON} \leq \frac{0.125 * (50\%)}{I_{o_ave}} = \frac{0.125 * 0.5}{6.25} = 0.010\Omega$$

$$R_{dsON} @ T_j=25^\circ C \leq \underline{10 m\Omega}$$

We can use 2-SO8 mosfets (IRF7853) in parallel having equivalent Rds_{ON} (@T_j=25°C) of ~9 mΩ.

Note : Vsd(@T_j=125°C) < 100mV would yield lower Rds_{ON} and can be achieve better thermal performance but it would mean raising the parts count and cost.

6.0 TEST WAVEFORMS

6.1.1 Transient Test

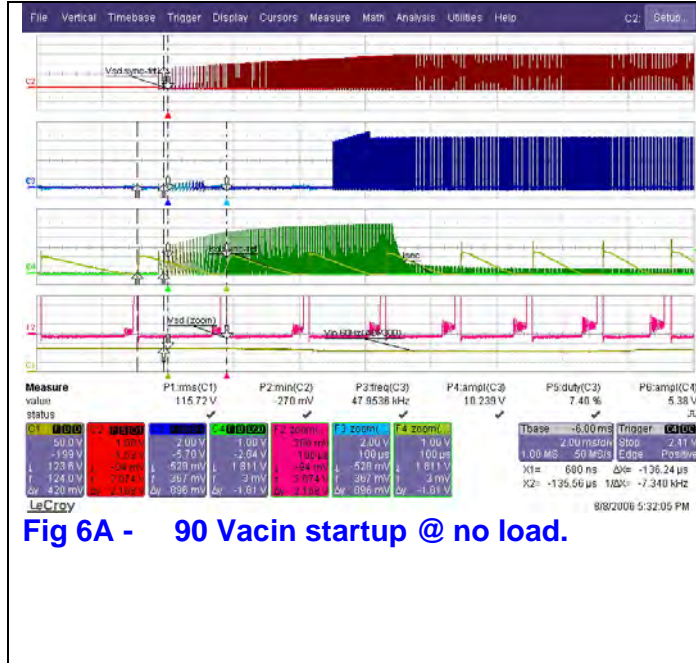

Fig 6A - 90 Vacin startup @ no load.

Ch1 : 50V/div, @ 90Vac
 Ch2 : 1V/div Vsd of sync rect (SR)
 Ch3 : 2V/div Vgate of SR1 & SR2 (IRF7853), F3: (zoom of Ch3)
 Ch4 (x10A/V) =Isd ~54 Apk (max)

2. Vsd of sync rects are quite clean
 3. The IR1166 IC start its sync rect oper'n only after ~3 msec from the first switching of the primary section. The body diodes of the sync rect mosfets act as the passive rectifiers during this particular period. The Gate drive (fsw : ~7.3kHz) pulses became so narrow after the output voltage stabilizes and reached the regulation at no load condition (-see Fig. 6G for more details).

4. Plot F4 is the zoom view of Ch4 (Isd) No significant reverse current during startup at full load.

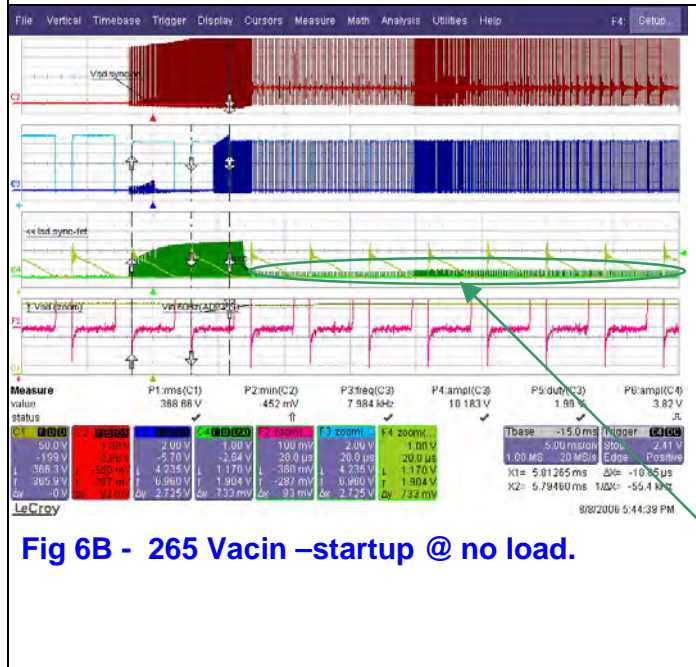

Fig 6B - 265 Vacin -startup @ no load.

Ch1 : 50V/div, @265Vac
 Ch2 : 1V/div, Vsd of sync rect (SR)
 Ch3 : 2V/div, Vgate,
 F3: (zoom of Ch3)
 Ch4 (x10A/V), Isd : ~38 Apk (max)

2. Vsd of sync-rects is uniform and switching regularly.

3. Gate drive pulses become narrow at light load condition and the switching frequency decreases after the output voltage reached its regulation level.

4. Plot F4 is the zoom view of Ch4 (Isd) - no significant reverse current during startup at full load. Narrow current pulses approx. ~7 to 8Apk (see Fig 6H) is keeping the Vout within regulation during standby mode (no load condition).

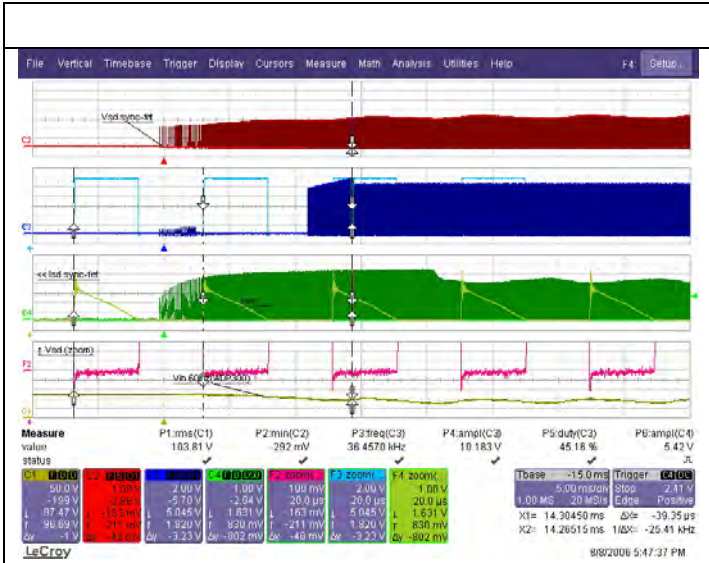

Fig 6C - 90 Vacin 100W full load startup.

- Ch1 : 90Vac = 125 Vin
 - Plot F2 : Zoom of Ch2 : Vsd of sync rect (SR)1 // SR2)
 - Ch3: Vgate, Plot F3 : zoom Vgate
 - Ch4 (x10A/V), Isd= ~55 Apk
2. Initial Vsd signals are uniformly switching at ~6kHz during the first 3 ms after power-up.
 3. Gate drive started ~11ms after power-up.
 4. Plot F4 is the zoom view of Ch4 (Isd). No significant reverse current during startup at full load. Current peaks are normally high during startup and settles to ~55Apk during normal 100W operation.

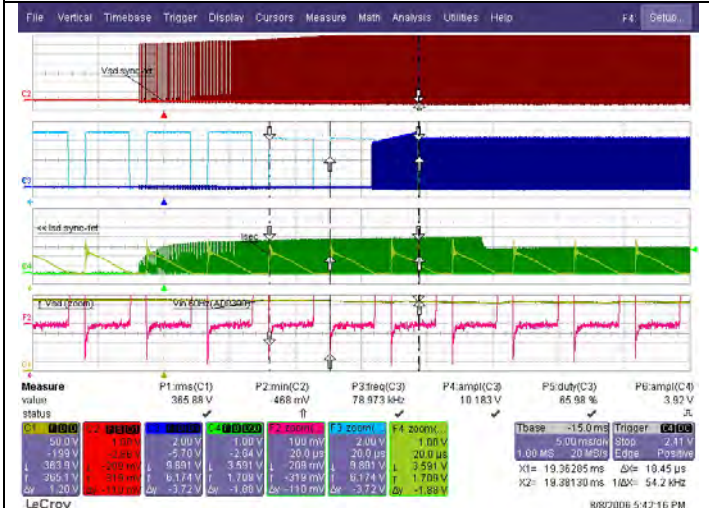

Fig 6D - 265 Vacin 100W full load startup.

- Ch1 100V/div: 372VDCin
 - Plot F2 : Zoom of Ch2 20V/div: Vsd of sync rect, (SR1 // SR2)
 - Ch3: Vgate, Plot F3 : zoom Vgate
 - Ch4 (x10A/V) , Isd= ~30-40 Apk
2. Vsd of sync-rects are uniform and initially switching at~6kHz during the first msec after power-up.
 3. Gate drive started after ~3.6ms from first Vsd switching.
 4. Plot F4 is the zoom view of Ch4 (Isd) has no significant reverse current during startup at full load. Current peaks are normally high but lower compared to low line startup. ~30Apk with normal 100W loading.

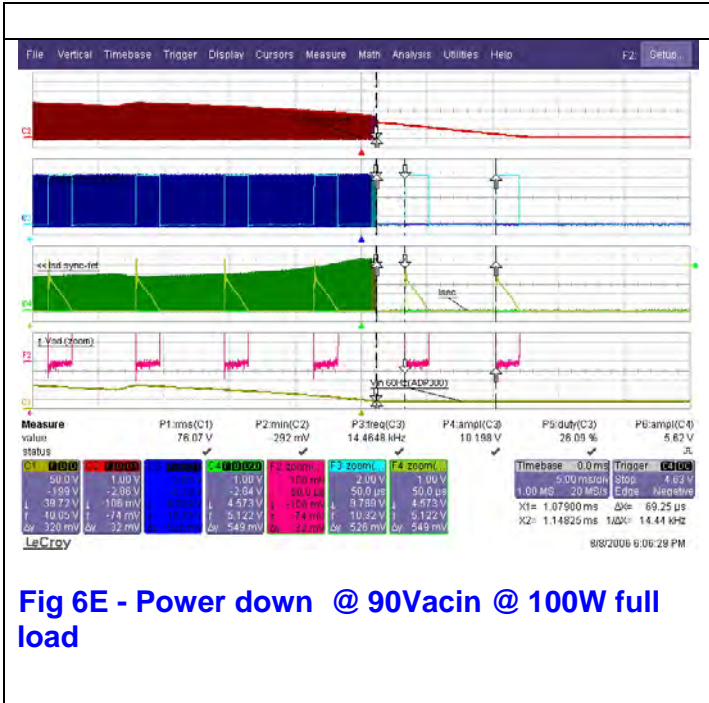

Fig 6E - Power down @ 90Vacin @ 100W full load

Ch1 : 90Vac = 125Vdc to ~44 Vdcin
 Ch2 : Vsd of sync rect (SR)1 // SR2
 Ch3: Vgate,, Plot F3 : zoom Vgate
 Ch4 @ x10A/V , Isd= ~56 Apk (max)

1. Switching stops after primary bulk voltage drops to ~40VDC.
2. (Plot F2) Vsd of sync-rects switching freq. at ~14kHz
3. Gate pulses stops probably due to IC's UVLO threshold has been reached after Vout continuously dropped.
4. Plot F4 is the zoom view of Ch4. Isd rises as the output tries to maintain constant current while Vout start to drop until the IR1166 IC reach UVLO and sync rectification stops.

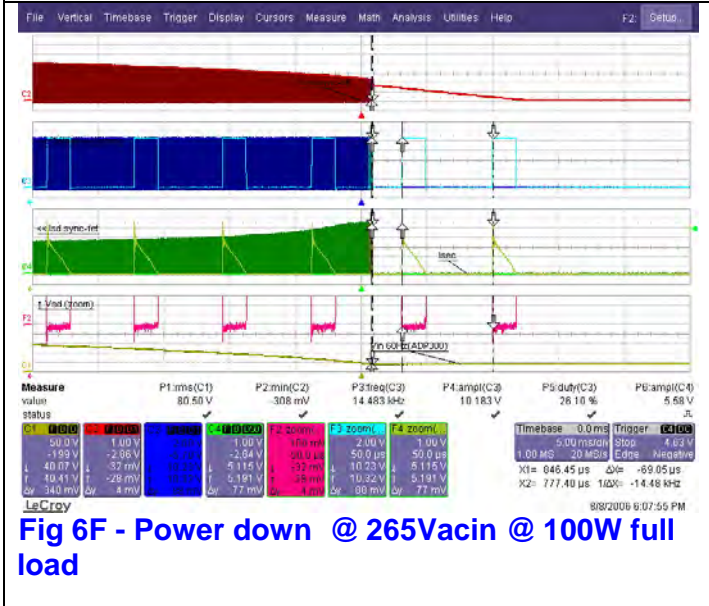

Fig 6F - Power down @ 265Vacin @ 100W full load

Ch1 : 100V/div
 Ch2 : 20V/div :VSD of sync rect (SR)1 // SR2
 Ch3: Vgate, Plot F3 : zoom Vgate
 Ch4 (x10A/V), Isd= ~56 Apk (max)

1. Switching stops after primary bulk voltage drops to ~40VDC.
2. Vsd of sync-rects were switching at ~14kHz before IC's UVLO was reached.
3. Sync-rect gate drive also stops when the switching at the primary side ceases.
4. Ch4 is showing Isd rise from ~35Apk to ~56Apk before the unit completely shutdown.

6.1.2 Static Load Test



Ch1 : 90Vac = 125 Vin
 Ch2 : 20V/div :VSD of sync rects (SR1) // SR2, IRF7853)
 Ch3: Vgate
 Ch4 (x10A/V), Isd= ~5 Apk

2. Vsd of sync-rects are switching at ~foldback freq (DCM oper'n) at no output load condition.

3. Vgate became a regular narrow (~1.14us) pulses switching @~14kHz (fix freq. DCM) during no load standby operation.

Fig. 6G - 90Vac in, 16Vout / no load (recaptured – closer view)

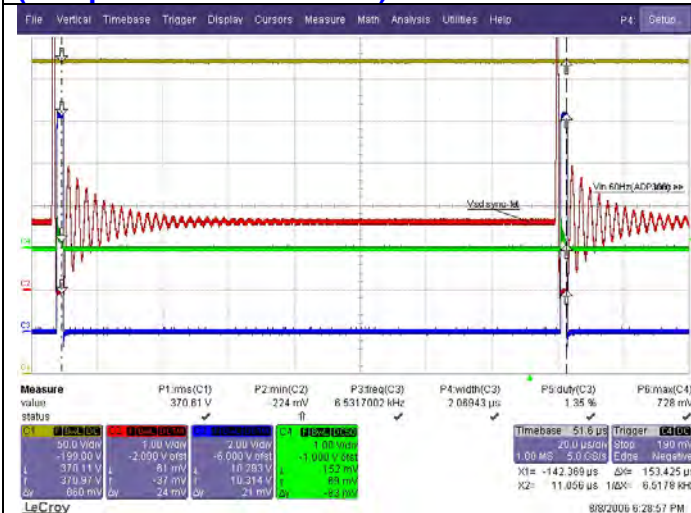

Fsw falls back to a fix low frequency around ~6kHz with gate pulse width reduce to a narrow ~2usec at high line - no load condition.

Fig. 6H - 265Vac in, 16Vout / no load (recaptured – closer view)

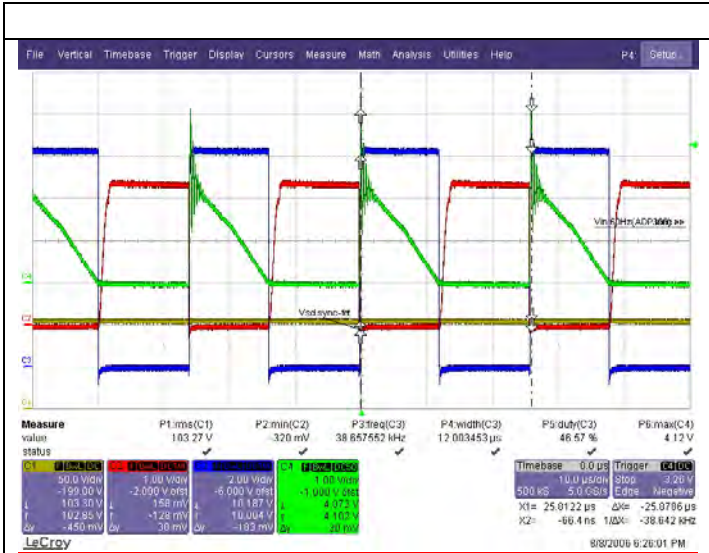

Ch1 : Vin
 Ch2 : VSD of sync rect
 Ch3 : Gate (2x IRF7853)
 Ch4 (x10A/V) = ~41 Apk (max)

2. Vd sense pin of the IC is under regular voltage stress of approximately 6% vs. 5V specs.

Fsw : ~38 kHz

Fig. 6I - 90Vacin, 16Vout / 6.25A full 100W load (recaptured – closer view)

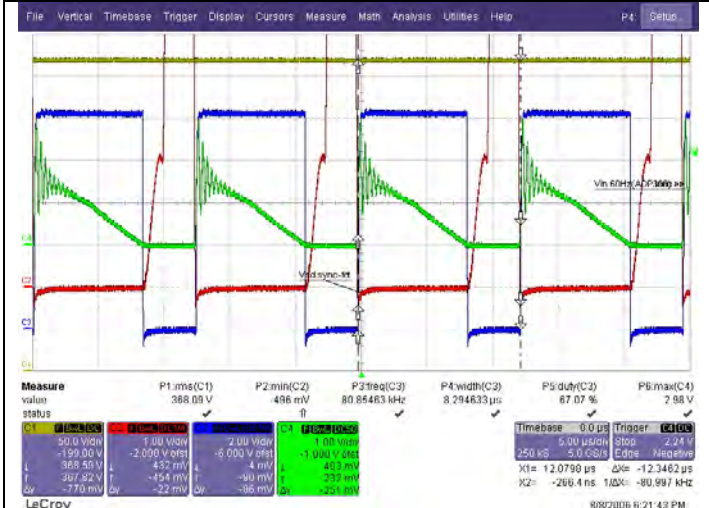

Vd sense pin of the IC is under regular voltage stress of approx. 1% vs. 5V specs.

Vgate : regular ~10.2V pulses
 Fsw : ~80 kHz

Fig. 6J - 265Vacin, 16Vout / 6.25A full 100W load (recaptured – closer view)

6.2 Ripple & Noise Measurement

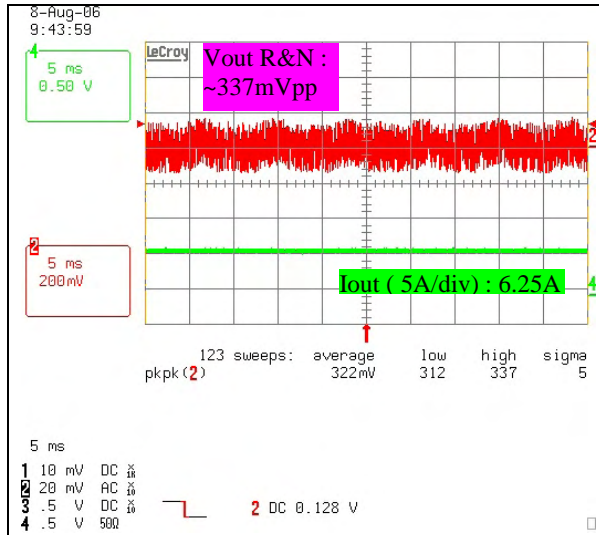

Fig. 6K 90Vacin, Ripple & Noise
16Vout / 6.25A full 100W load

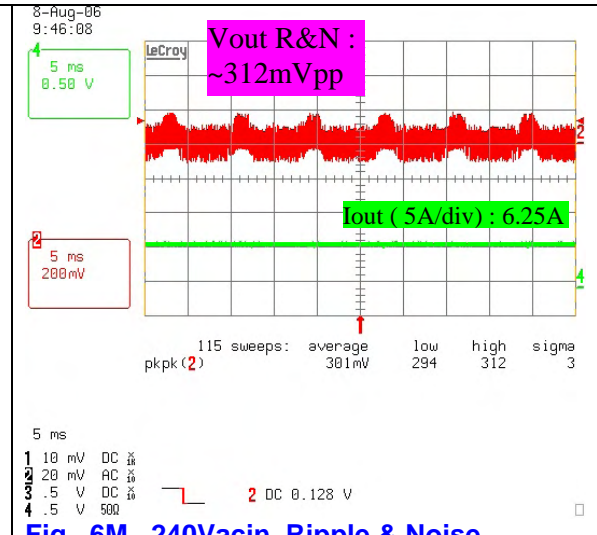

Fig. 6M 240Vacin, Ripple & Noise
16Vout / 6.25A full 100W load

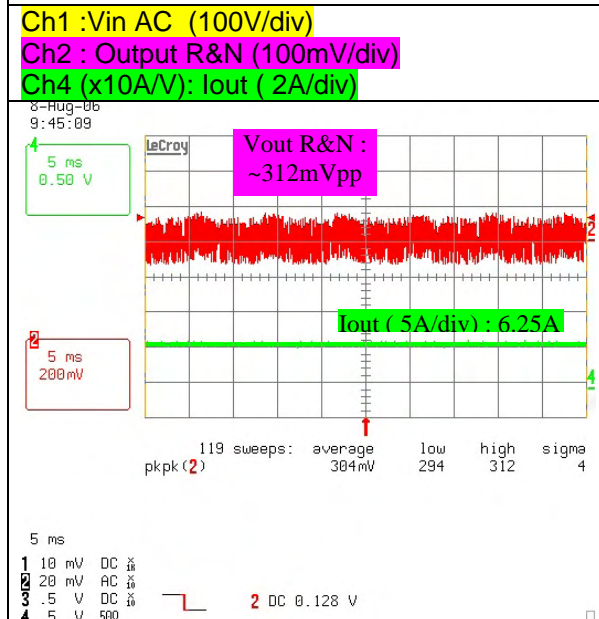

Fig. 6L 115Vacin, Ripple & Noise
16Vout / 6.25A full 100W load

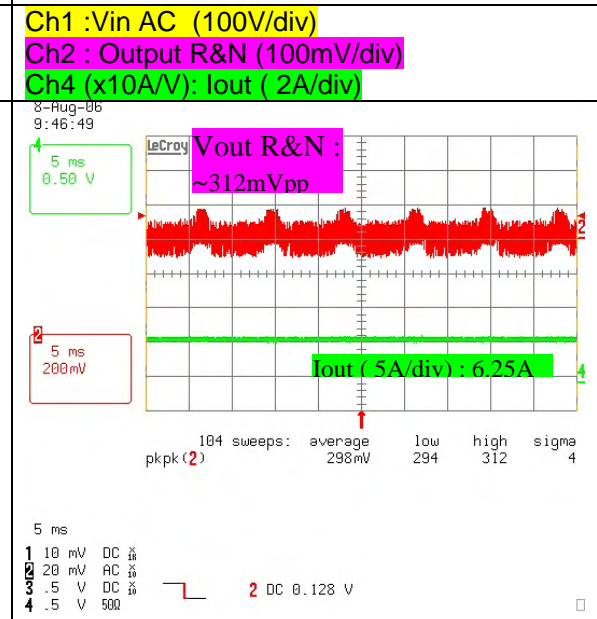
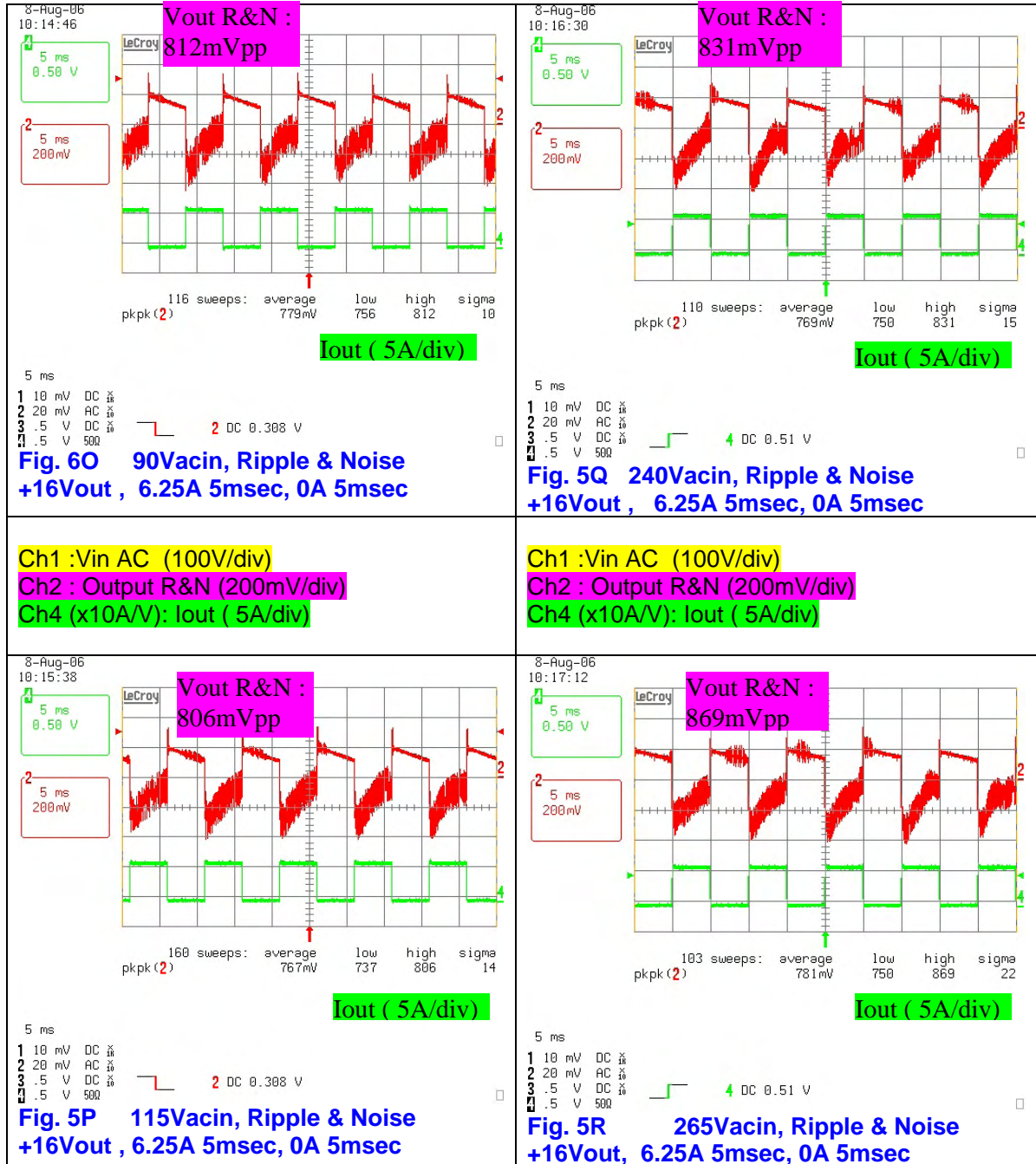

Fig. 6N 265Vacin, Ripple & Noise
16Vout / 6.25A full 100W load

6.3 Dynamic Load Test (0 – 100% rated load, +/- 800mA/usec)



6.4 Startup & UVLO Test

Ch1 : Vin DC 50V/div,
Ch2 : Vgate

Ch3 : Vcc IR1166 IC
Plot B : Zoom of Vgate (Ch2)

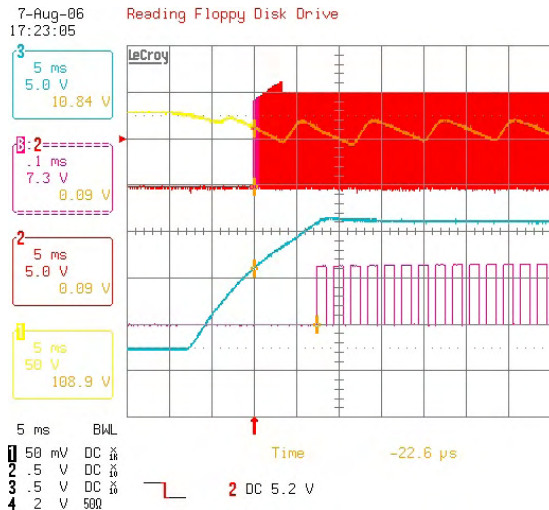

Fig. 6S – Startup at 90Vacin, full load

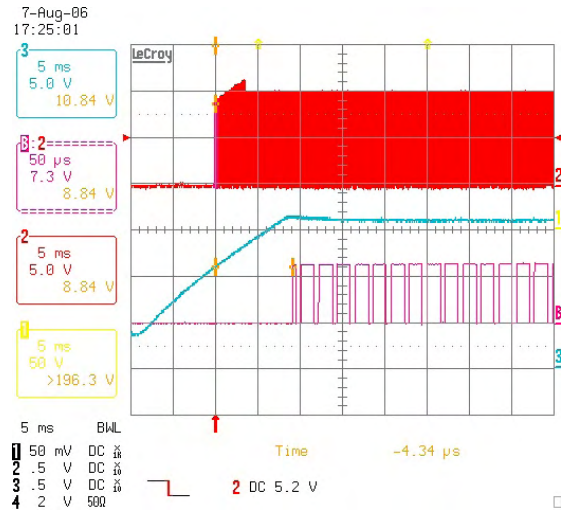

Fig. 6U – Startup at 265Vacin, full load

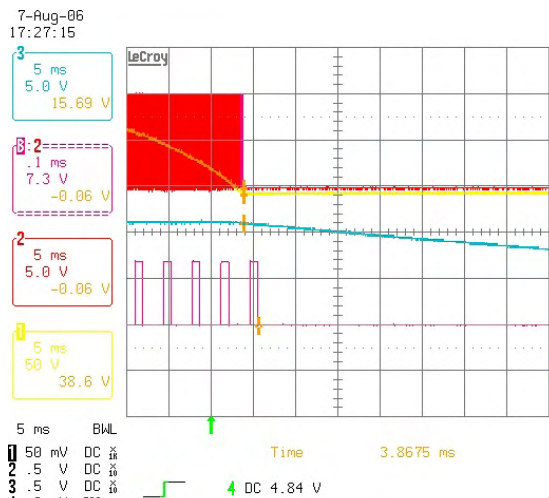

Fig. 6T – Power down at 90Vacin, full load

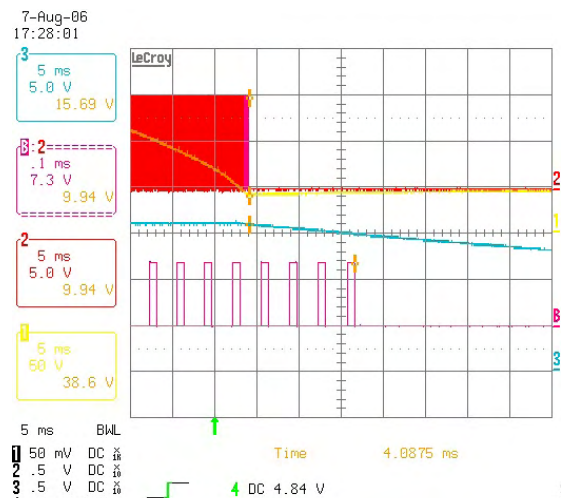

Fig. 6V –Power down at 265Vacin, full load

7.0 LINE/LOAD REGULATION TEST

7.1 IR1166 Demo Board V-I Characteristics						
			Table 2			
Vin	90	115	180	220	230	265
Iout (A)	Vout (V)	Vout (V)	Vout (V)	Vout (V)	Vout (V)	Vout (V)
0	16.12	16.11	16.12	16.12	16.12	16.12
1	16.12	16.12	16.12	16.12	16.12	16.12
2	16.12	16.12	16.12	16.12	16.12	16.12
3	16.12	16.12	16.12	16.12	16.12	16.12
4	16.12	16.12	16.12	16.12	16.12	16.12
5	16.11	16.11	16.12	16.12	16.11	16.12
6	16.09	16.09	16.09	16.10	16.10	16.10
6.25	16.09	16.09	16.10	16.10	16.10	16.10
6.5	16.09	16.10	16.11	16.11	16.11	16.11
6.75	13.91	13.82	13.91	13.88	13.93	13.98
7	10.60	10.58	10.55	10.66	10.73	10.78
7.25	Bounce	Bounce	Bounce	Bounce	Bounce	Bounce

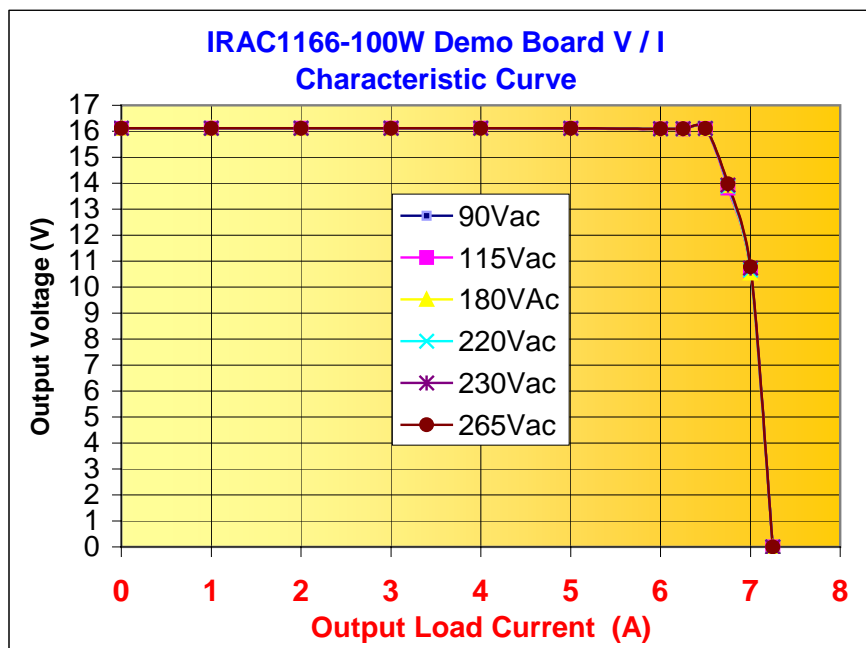

Figure 7.1. Output Voltage vs. Load Current Characteristic Curve

7.2 System Efficiency Test

Table 3

VinAC	Vout V	Iout (A)	Pout (W)	Pin (W)	Efficiency
90	16.001	6.25	100.0	118.0	86.52%
115	16.001	6.25	100.0	115.3	87.3%
240	16.001	6.25	100.0	115.0	87.5%
265	16.001	6.25	100.0	116.0	87.7%

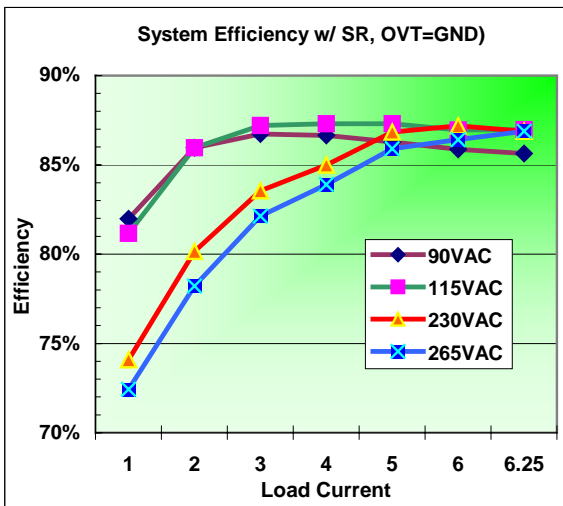

Fig. 7.2A System Efficiency with OVT = Gnd

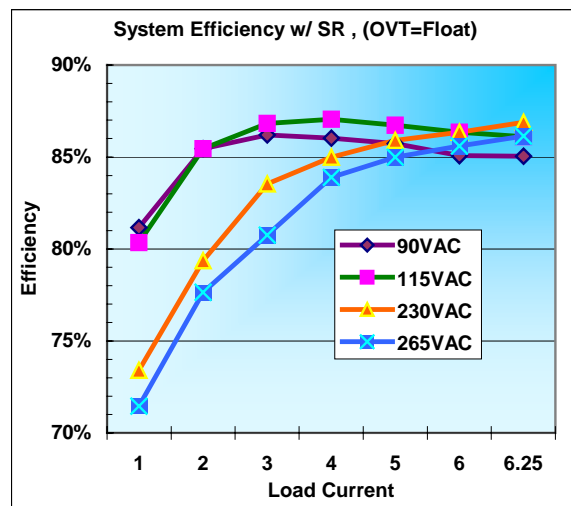

Fig. 7.2B System Efficiency w/ OVT = Float

7.3 Thermal Verification

Table 4

IRAC1166-100W	90VACin	265VACin	90VACin	265VACin
Ambient Temp	25.9	26.2	50.4	50.4
IR1166 (SO-8 IC)	64.2	61.4	85.1	84.7
SR1 (IRF7853 SO8 FET)	81.9	76.8	106.9	99.8
SR2 (IRF7853 SO8 FET)	79.8	75.8	103.0	98.2
Q1 (IRF22N60K)	56.1	80.2	80.2	99.2
DP1 (UF5407) Snubber diode	60.2	70.2	84.3	88.8
330uF/400V MXR Bulk Ecap	53.8	51.4	76.2	64.9
Power transformer (PQ3535)	72.5	80.5	92.0	98.0
Input bridge rectifier	82.7	52.1	100	75.2
Pin (W)	115.6	115.0	115.1	114.1
Vout (A)	16.002	16.002	16.002	16.002
Iout (A)	6.250	6.250	6.250	6.250
Efficiency (%)	86.52	86.96	86.9	87.65

Note : All case temperature in °C.

8.0 Summary :

This demo board showcases the performance of IR1166 SmartRectifier Control IC to drive mosfets (as synchronous rectifiers) by simple fast-rate direct-voltage-sensing technique. It also featured the flexibility of the IC to cope with different current conduction modes of flyback converter designs.

The low-side synchronous rectification is fully demonstrated in this demo board, which operates in variable frequency critical conduction mode (VF-CrCM). This configuration has lead to achieve better efficiency and a much simpler overall system design normally required in single output flyback high current applications such those use in laptop power adaptors.

This 100W demo board has shown the efficiency improvement using low voltage SO8 mosfets – replacing the traditional Schottky rectifiers - has brought a string of advantages such as avoiding the use of heavy heat sinks and simple gate drive circuit for the synchronous mosfets. This design simplification has resulted to saving in PCB area due to reduction of part counts and elimination of bulky heat sink.

9.1 Transformer turns ratio, Duty Cycle and Secondary Current Relationship

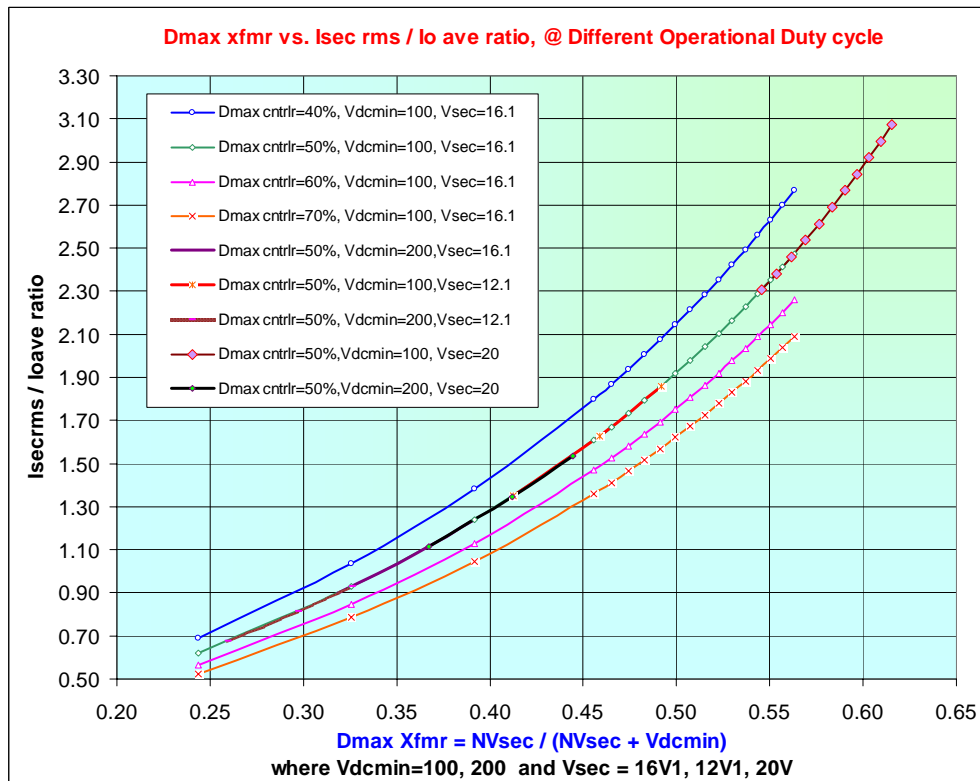

Fig. 9.1 Graphical estimation chart for $I_{sec\ rms} / I_{o\ ave}$

9.2 IRAC1166-100W +16V SR Demo Board Power Transformer Specification

Winding W1 : 15 turns 2 x AWG#20
 Winding W2 : 5 turns 3 x TIW (0.55 mm)
 Winding W3 : 5 turns 3 x TIW (0.55 mm)
 Winding W4 : 5 turns AWG#30
 Winding W5 : 5 turns 3 x TIW (0.55 mm)
 Winding W6 : 16 turns 2 x AWG#20
 Core type : PQ3535
 Ferrite material : PC44 TDK / Nicera equivalent

Lpri : 250uH +/-15% (pin 6-4)
 Finishing : Dip varnish / vacuum

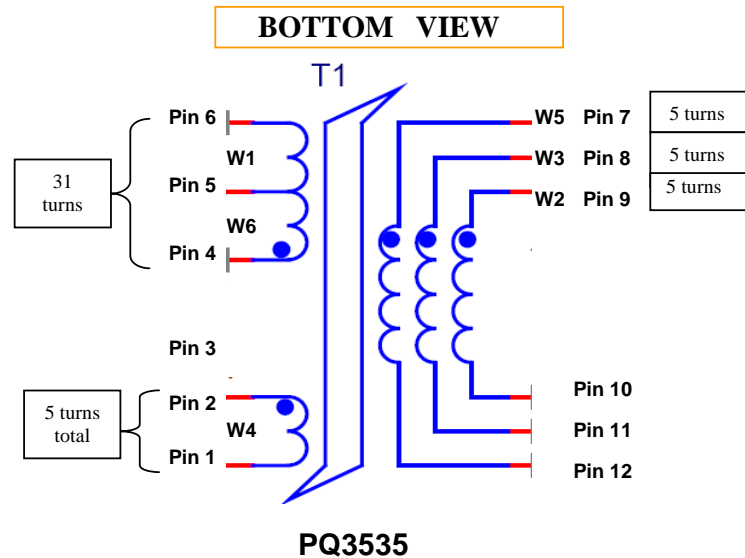

Fig. 9.2 Power transformer Winding Termination Diagram
 Note : TIW = triple insulated wire

10.0 IRAC1166-100W +16V Demo Board Bill of Material (BOM)

NOTE: TH = Through-hole Date : 28-Jun-06

Item #	Qty.	Value	Part Ref.	Description	Manuf. PN.
1	1	2-PIN	CON1	2 way connector (TH)	PN: 5417 or List No. : 39-26-3030
2	1	4-PIN	CON2	4 way connector (TH)	PN: 5417 or List No. : 39-26-3040
3	1	220NF/275V	CP1	KNB1560 0.22UF 10% 275 L30 R15 (TH)	KNB1560 0.22UF 10% 275 L30 R15
4	1	4NF7/1KV	CP2	CAPACITOR, 4.7NF 1000V (TH)	DEBF33A472ZC1B (Murata)
5	1	330UF/400V	CP3	CAPACITOR, 330UF 400V (TH) - prime	400MXR330M35X35 (Rubycon)
5A				-alternate	EET-ED2G331EA - (Panasonic)
6	1	4NF7/1KV	CP4	CAPACITOR, 4.7NF 1kV (TH)	DEBF33A472ZC1B (Murata)
7	1	100UF/35V	CP5	CAPACITOR, 100UF 35V (TH)	UPL1V102MHH6 NICHICON
8	1	0.1UF	CP6	CAPACITOR, 1206 100 NF 50V	12065C104KAT00J
9	1	470PF 1KV	CP7	CAPACITOR, 470PF 1kV ((TH)	DEBB33A471KC1B (Murata)
10	1	0.22UF	CP8	CAPACITOR, 1206 220NF 50V	12065G224ZAT2A (AVX)
11	1	22PF	CP9	CAPACITOR, 1206 22PF 50V	12061A220JAT2A (AVX)
12	1	10NF	CP10	CAPACITOR, 1206 10NF 50V	12065G103ZAT2A (AVX)
13	1	4N7F	CP11	CAPACITOR, 1206 4.7NF 50V	12065C471KAT2A (AVX)
14	1	22PF	CP12	CAPACITOR, 1206 22PF 50V	12061A220JAT2A (AVX)
15	1	1N5	CP13	CAPACITOR, X1/Y1 1.5NF (TH)	DE1E3KX152MA5B (Murata)
16	1	1000UF/25V	CS14, CS15	CAPACITOR, 1000UF 25V (TH)	25ZL1000M12.5X20 (Rubycon)
17	1	1500UF/25V	CS16	CAPACITOR, 1500UF 25V (TH)	25ZL1500M12.5X25 (Rubycon)
18	1	22UF/35V	CS17	CAPACITOR, 22UF 50V (TH)	50ZL22M5X11 (Rubycon)
19	1	100NF	CS18, CS24	CAPACITOR, 1206 100NF 50V	12065C104KAT00J (AVX)
20		UNSTUFFED	CS19	UNSTUFFED	
21	1	47NF	CS20	CAPACITOR, 1206 47NF 50V	12065C473KAT2A (AVX)
22	2	10NF	CS21,CS22, CS25	CAPACITOR, 1206 10NF 50V	12065C103KAT2A (AVX)
23	1	820UF/25V	CS23	CAPACITOR 820UF, 25V (TH)	EEUFC1E821.
24	1	6GBU06	DB1	6-Amp 800V Bridge rectifier diode (TH)	6GBU06 - (Gen. Semi)
25	1	UF5407	DP1	Ultrafast DIODE, 3A 800V (TH)	UF5407 (Gen. Semi)
26	1	BAV103/200V	DP2	DIODE, SWITCHING SOD-80C	Philips BAV103
27	3	LS4148	DP3,DP4,DS5	DIODE, QUADRO-MELF	LS4148 (VISHAY)
28	1	T3.15A/250V	F1	FUSE, TR5 ANTISURGE 3.15A, (TH)	19372K 3.15A.
29	1	Test hook point	GND,G	TERMINAL, PCB Raised Loop Black (TH)	200-203 (W HUGHES)
30	1	Test hook point	Gate Drv	TERMINAL, PCB Raised Loop White (TH)	200-201 (W HUGHES)
31	1	Wire Jumper	J1	Jumper wire 0.7 diameter, 19 mm (TH)	
32	1	Wire Jumper	J2	Jumper wire 0.7 diameter, 11mm (TH)	
33	1	JUMPER1	J3	Three way jumper (TH)	M22F2010305 (HARWIN)
34	2	JUMPER1	J4, J5	Two-way jumper (TH)	M22-2010205 (HARWIN)
35	1		for J3	Jumper Head (blue)	M22-1910005 (HARWIN)
36	1		for J4	Jumper Head (Black)	M22-1900005 (HARWIN)
37	1		for J5	Jumper Head (Red)	M22F19200005 (HARWIN)
38	1	10uH	L1	Ferrite drum core inductor, axial (TH)	B78108-S1103-K - EPCOS
39	1	40uH	L2	Common mode choke -TH	019-4685-00R - Precision Inc.

40	1	1uH 8A	L3	8Amp Ferrite Rod Inductor- (TH) prime	PG0203 -Pulse Electronics
				alternate	019-4698-00R - Precision Inc.
41	1	LED	LED1	LED Green - TH	L-1413GDT
42	1	IRFP22N60K	Q1	TO-247 600V 22Amp N-ch Mosfet (TH)	- IR
43	1	10R	RP1	NTC Thermistor 10ohm 3Amp (TH) prime	B57235S100M - EPCOS
44	1	47K 2W	RP2	RESISTOR, 2W 5% 47K - (TH)	MCF 2W 47K
45	1	22R	RP3	RESISTOR, 0.25W 5% 22R (TH)	MCF 0.25W 22R.
46	1	3k3	RP4	RESISTOR, 1206 3K3	MC 0.125W 1206 1% 3K3
47	1	0R	RP5	RESISTOR, 1206 0R 5%	MC 0.125W 1206 0R
48	1	910K	RP6	RESISTOR, 1206 910K	MC 0.125W 1206 5% 910K
49	2	5.1k	RP7, RS24	RESISTOR, 1206 5.1K;	MC 0.125W 1206 1% 5.1K
50	1	22R	RP8	RESISTOR, 1206 22R	MC 0.125W 1206 5% 22R
51	3	1K	RP9, RP12,RS22	RESISTOR, 1206 1K	MC 0.125W 1206 1% 1K
52	1	12K	RP9A	RESISTOR, 1206 12K	MC 0.125W 1206 5% 12K
53	1	0R1	RP10	RESISTOR, WW 3W 5% 0R1 (TH)	WELWYN W210R1J1
54	1	280K	RP11	RESISTOR, RC12H 1206 280K	MC 0.125W 1206 5% 280K
55	1	2K2	RS13	RESISTOR, 1206 2K2	MC 0.125W 1206 5% 2K2.
56			RS14	UNSTUFFED	
57	2	10R	RS15,RS17	RESISTOR, 1206 10R	MC 0.125W 1206 5% 10R
58	1	4K7	RS16	RESISTOR, 1206 4K7	MC 0.125W 1206 5% 4K7
59	1	10K	RS18	RESISTOR, 1206 10K	MC 0.125W 1206 5% 10K
60		UNSTUFFED	RS19, RS26	UNSTUFFED	
61	1	430R	RS23	RESISTOR, RC02H 1206 470R	RC-02H-470R-1P5.
62	2	10K	RS20, RS21	RESISTOR, 1206 10K	MC 0.125W 1206 1% 10K
63	1	30m	RS25	RESISTOR, SMD 1% 0R030	OARS1 - R030FI.
64	2	IRF7853	SR1, SR2	SO-8 N-ch 100V 18mohm MOSFET	IR
65	1	PQ3535	T1	PQ3535 100W Flyback Power Transformer (TH)	019-4563-00 Rev 01 - Precision Inc.
66	1	IR1166	U1	SO-8 Flyback Sync Rectifier Smart Controller IC	IR
67	1	TEA1507	U2	GreenChip™ II SMPS control IC DIP8 (TH)	TEA1507 -PHILIPS
68	1	SFH615A2	U3	SFH615A2 DIP 4 option G Optocoupler (TH)	SFH615A-2 -Vishay (Infineon)
69	1	AS4305 or AQ105	U4	SOT23-5 Secondary V-I Error amplifier	Siliconlink or Acutechnology
70	1	Test hook point	VCC-HP	TERMINAL, PCB Raised Loop - Red (TH)	200-207 - W HUGHES
71	2	Test hook point	VD-HP, VD1-HP	TERMINAL, PCB Raised Loop- Yellow (TH)	200-202 - W HUGHES
72	1	Test hook point	VS, VS1	TERMINAL, PCB Raised Loop BLACK (TH)	200-203 - W HUGHES
73	1	Pri - Heatsink		10.4DegC/W, Black anodized extruded heat sink - radial fins & notched base and solderable pins	531102B02500G -Aavid Thermalloy
74	4	Screw + washer	For Nylon standoff	SCREW with washer M3X6 P=.5	SEM02030006FA (Nettlefolds)
75	1	Screw		M3 x 12, For Primary heat sink	MB04030012007FA (Nettlefolds)
76	2	Spring Washer		M3, 1mm thick For Primary heat sink	WS210300081FA (unbranded)
77	1	Nut		HEX NUT M3X0.5X1.8 - For Pri Heatsink	NC010300081FA (unbranded)
78	1	Insulator	For Q1 (TO247)	Silpad K-10 or K-4, 25.5mm x 19.1mm (0.2 -0.4 degCin ² /W Bergquist)	0900 000 5350 (HARTING)
79	4	Nylon Standoff	TRANSPILLAR, HEX STYLE 3 M3X38;	Depth, thread:4.5mm; External Diam.:7mm; Head type: Hexagonal; Height, spacer:38mm; Length / Height, external:38mm; Thread size:M3	SCHURTER- 9633.83
80	1	PCB	PCB	1.6mm thick 2-sided 2 oz, UL rated 94V-0	