

PulseJack® 2xN Gigabit PoE Plus

U.S. Patent#7241181

Description:

10/100/1000Base-T RJ45 2xN PoE Plus Integrated Connector with Magnetics, with the addition of power feeding over signal pairs.



Features and Benefits:

- Ⓜ RoHS peak wave solder temperature rating 260°C
- Ⓜ Suitable for CAT 5 & 6 UTP cable or better
- Ⓜ Power over Ethernet Plus (PoE+) enabled
- compatible to IEEE 802.3at standard
- Ⓜ 350μH minimum OCL with 18.3mA DC bias current
- Ⓜ High performance for maximum EMI suppression

Electrical Specifications @ 25°C - Operating Temperature 0°C to +70°C

RoHS Compliant Part Number (Number of Ports)	PoE Enabled	Turns Ratio (±2%)	Insertion Loss TX/RX (dB TYP)	Return Loss (dB TYP) 100Ω (±15Ω)				Crosstalk (dB TYP)			Common Mode Rejection		Hipot (Vdc MIN) (dB TYP)
				1-100 MHz	1-40 MHz	60 MHz	100 MHz	1-10 MHz	30-60 MHz	60-100 MHz	1-10 MHz	10-150 MHz	
JOB-0384NL (2X4)	YES	1:1	-1.4	-18	-14	-10	-50	-41	-31	-50	-30	2250	
JOB-0386NL (2X6)	YES	1:1	-1.4	-18	-14	-10	-50	-41	-31	-50	-30	2250	
JOB-0388NL (2X8)	YES	1:1	-1.4	-18	-14	-10	-50	-41	-31	-50	-30	2250	

Notes: Contact Pulse for LED options

RJ45 Durability Test Rating

Part Number	Mating Force (MAX)	Unmating Force (MAX)	Durability
JOB Series	5 lbs./2.268 kgs.	5 lbs./2.268 kgs.	750 Insertions

RJ45 Material Specification

Part Number	Shield		Contact			Housing		MSL ² Rating
	Material	Finish	Material	Plating Area	Solder Area	Material	Specification	
JOB Series	Brass	20-40μ inches thick nickel over brass	Phosphor Bronze	50μ inches gold over 30-50μ inches nickel	Tin matte finish over nickel	Thermoplastic	UL 94 V-0	1

Notes:

1. Connector dimensions comply with FCC dimension requirements.

USA 858 674 8100

Germany 49 7032 7806 0

Singapore 65 6287 8998

Shanghai 86 21 62787060

China 86 755 33966678

Taiwan 886 3 4356768

2X4 Mechanicals (No LEDs)

JOB-0384NL

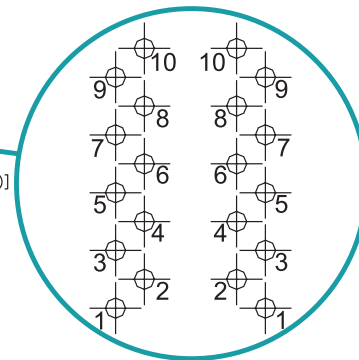
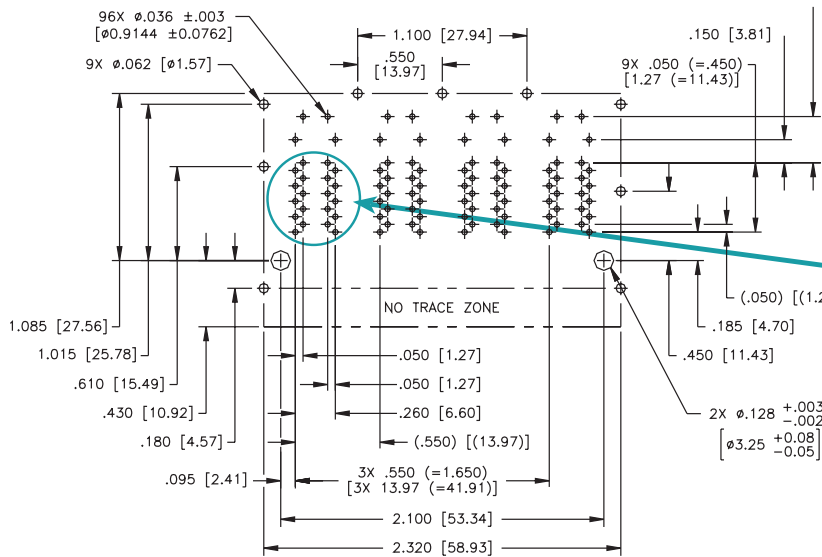
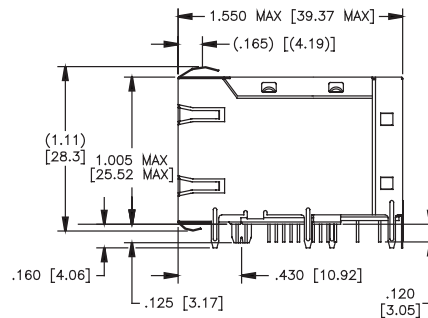
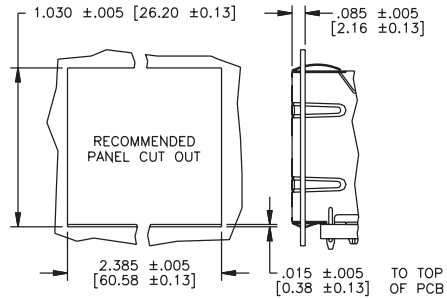
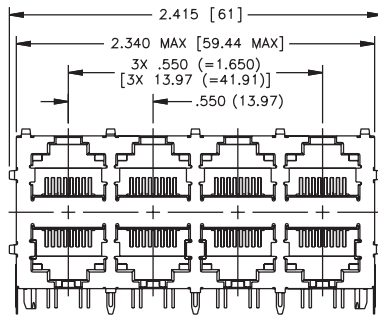
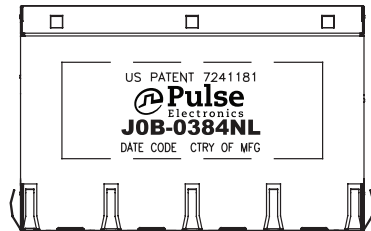

2X6 Mechanicals (No LEDs)

JOB-0386NL

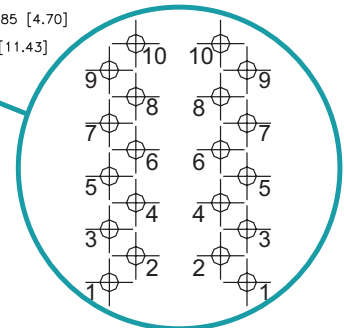
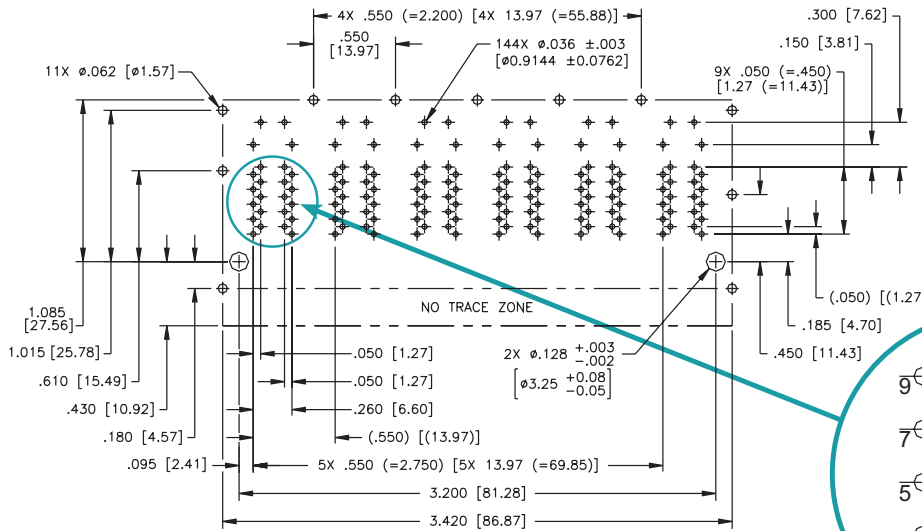
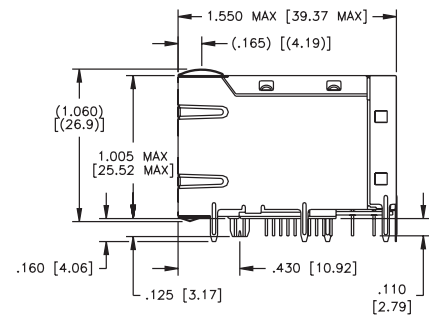
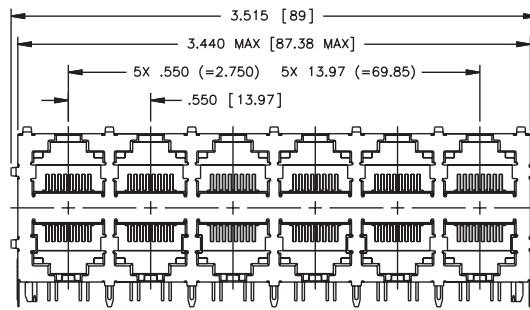
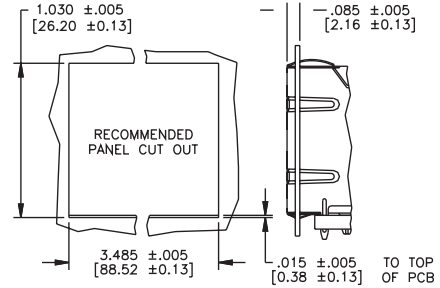
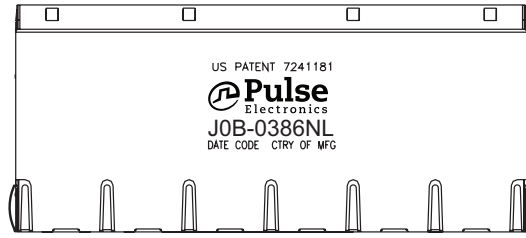

Pin-out Assignment

PulseJack® 2xN Gigabit PoE Plus

U.S. Patent#7241181



2X8 Mechanicals (No LEDs)

JOB-0388NL

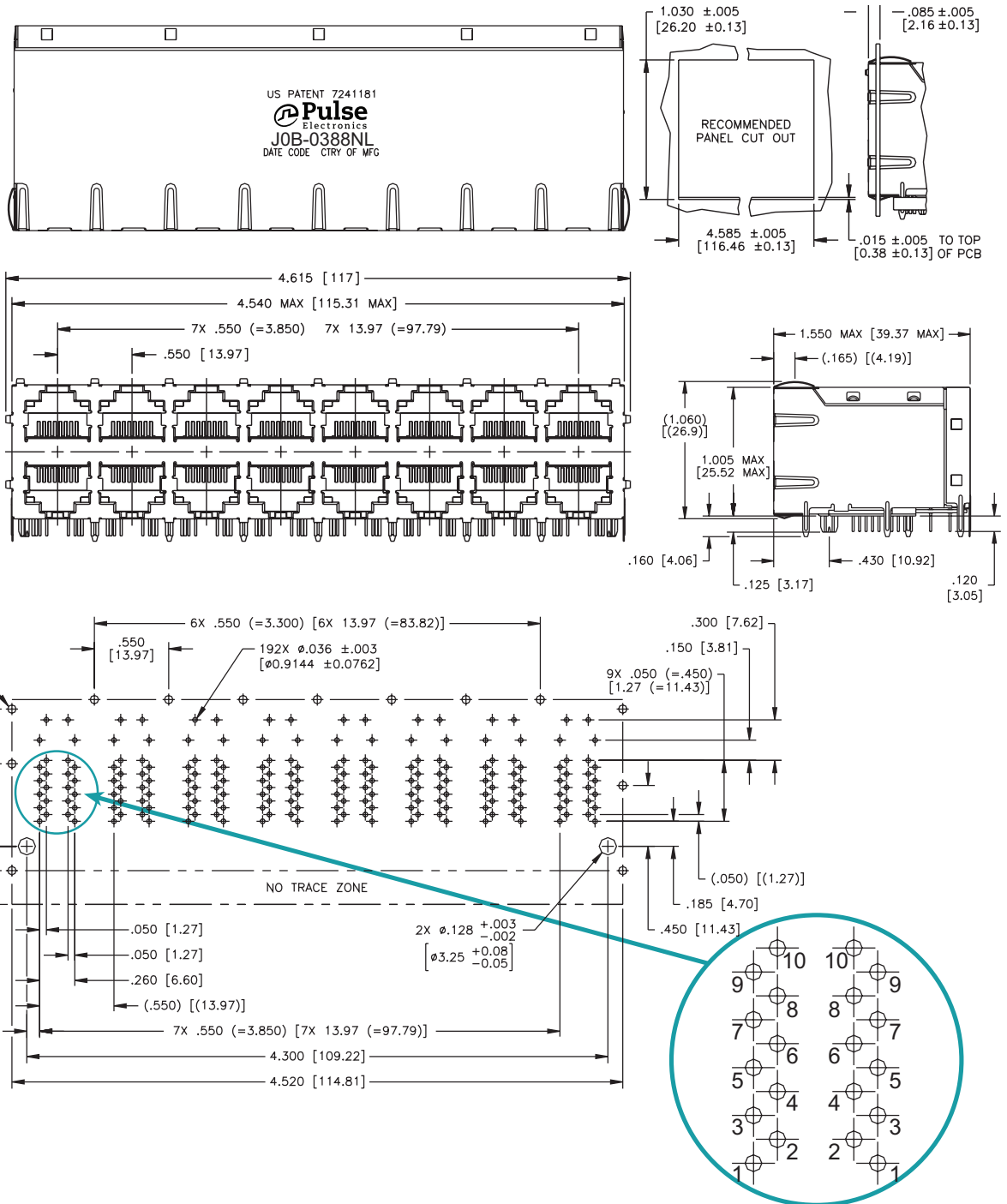

Pin-out Assignment

PulseJack® 2xN Gigabit PoE Plus

U.S. Patent#7241181

JOB-0384NL/86NL/88NL

Pin-out Assignment

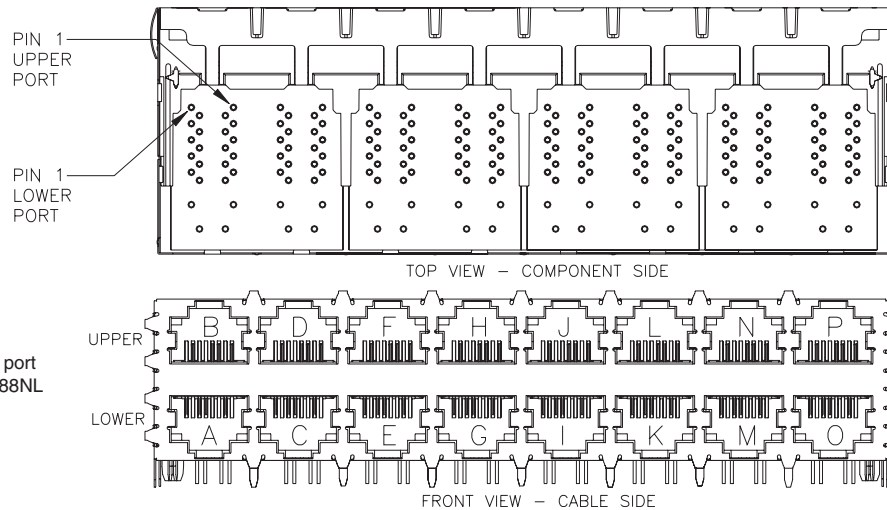

NOTE: All parts use the same port identification system. JOB-0388NL (2x8) shown here.

Schematic

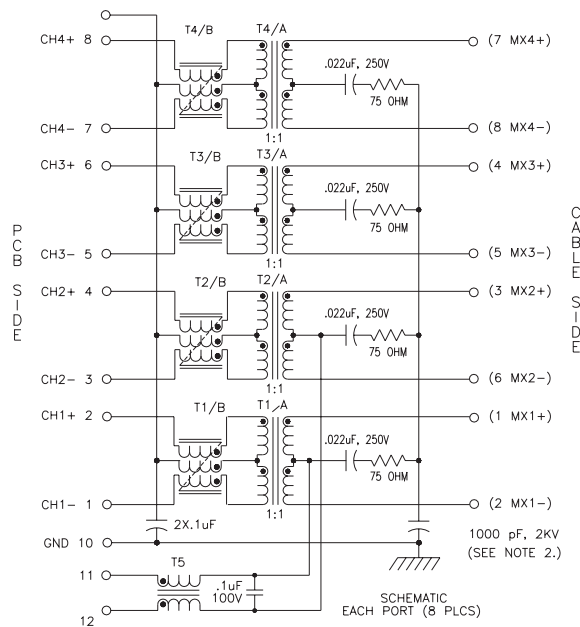

For More Information

Pulse Worldwide Headquarters
12220 World Trade Drive
San Diego, CA
92128
U.S.A.

Tel: 858 674 8100

Pulse Europe
Einsteinstrasse 1
D-71083 Herrenberg
Germany

Tel: 49 7032 7806

Pulse China Headquarters
B402, Shenzhen Academy of
Aerospace Technol-
ogy Bldg.
10th Kejian Road
High-Tech Zone
Nanshan District
Shenzhen, PR China
518057

Pulse North China
Room 2704/2705
Super Ocean Finance
Ctr.
2067 Yan An Road
West
Shanghai 200336
China

Pulse South Asia
135 Joo Seng Road
#03-02
PM Industrial Bldg.
Singapore 368363

Tel: 65 6287 8998
Fax: 65 6287 8998

Pulse North Asia
3F, No. 198
Zhongyuan Road
Zhongli City
Taoyuan County 320
Taiwan R. O. C.
Tel: 886 3 4356768
Fax: 886 3 4356823
(Pulse)

Performance warranty of products offered on this data sheet is limited to the parameters specified. Data is subject to change without notice. Other brand and product names mentioned herein may be trademarks or registered trademarks of their respective owners. © Copyright, 2014, Pulse Electronics, Inc. All rights reserved.