

EVALUATION KIT
AVAILABLE

Triple 1.2A USB Switch in 4mm x 4mm Thin QFN

MAX1564

General Description

The MAX1564 triple, current-limited USB switch comes in a space-saving, 16-pin, 4mm x 4mm thin QFN package. Each channel meets all IEC specifications for USB ports. The device is capable of supplying up to 1.2A from each output. The MAX1564 has multiple protection features, including thermal shutdown to limit junction temperature in case of a prolonged short or overload condition. Reverse-current protection circuitry blocks current flow from output to input regardless of the switch state. The IC has accurate, user-programmable current-limiting circuitry to protect the input supply against overload.

Each output of the MAX1564 has short-circuit protection that latches off the switch when the output is shorted for more than 20ms, thereby saving system power. Auto-restart then tests the shorted output with a 25mA current to determine when the short is removed, then automatically restarts the output. Independent open-drain fault signals notify the microprocessor that the internal current limit has been reached. A 20ms fault-blanking feature allows momentary faults to be ignored, such as those caused when hot-swapping into a capacitive load. This feature helps avoid issuing false alarms to the host system. Blanking also suppresses errant fault signals when the device is powering up.

Applications

USB Ports
USB Hubs
Notebook Computers
Desktop Computers
Docking Stations

Features

- ◆ Tiny 16-Pin 4mm x 4mm Thin QFN Package
- ◆ Reverse-Current Blocking
- ◆ Programmable Current Limit
- ◆ Auto-Restart when Fault Is Removed
- ◆ 12% Accurate Current Limit
- ◆ Up to 1.2A Load Current for Each Output
- ◆ Thermal-Overload Protection
- ◆ Built-In 20ms Fault Blanking
- ◆ Compliant with All USB Specifications
- ◆ 2.7V to 5.5V Input Supply Range
- ◆ Independent Fault Indicator Outputs
- ◆ Active-High/Active-Low Select Pin
- ◆ $\pm 15\text{kV}$ ESD Protection (with Caps)

Ordering Information

PART	TEMP RANGE	PIN-PACKAGE
MAX1564ETE	-40°C to +85°C	16 Thin QFN-EP* 4mm x 4mm

*EP = Exposed pad.

Pin Configuration

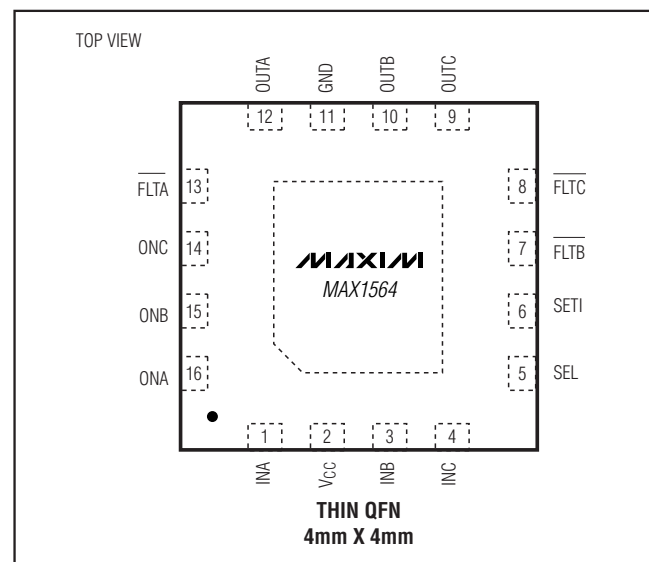

Triple 1.2A USB Switch in 4mm x 4mm Thin QFN

ABSOLUTE MAXIMUM RATINGS

IN ₋ , ON ₋ , OUT ₋ , SEL, V _{CC} to GND (Note 1)	-0.3V to +6V
FLT ₋ , SET1 to GND	-0.3V to (V _{CC} + 0.3V)
IN ₋ to OUT ₋ (when disabled, Note 2)	-6V to +6V
IN ₋ to OUT ₋ (when enabled, Note 3)	-1.5A to +2.3A
FLT ₋ Sink Current	20mA

Continuous Power Dissipation	16-Pin 4mm x 4mm Thin QFN
(derate 16.9mW/°C above +70°C)	1349mW
Operating Temperature Range	-40°C to +85°C
Junction Temperature	+150°C
Storage Temperature Range	-65°C to +150°C
Lead Temperature (soldering, 10s)	+300°C

Note 1: INA, INB, INC, and V_{CC} must be connected together externally.

Note 2: Reverse current (current from OUT₋ to IN₋) is blocked when disabled.

Note 3: Forward and reverse current are internally limited.

Stresses beyond those listed under "Absolute Maximum Ratings" may cause permanent damage to the device. These are stress ratings only, and functional operation of the device at these or any other conditions beyond those indicated in the operational sections of the specifications is not implied. Exposure to absolute maximum rating conditions for extended periods may affect device reliability.

ELECTRICAL CHARACTERISTICS

(V_{IN-} = V_{CC} = V_{SEL} = V_{ON-} = 5V, R_{SET1} = 26.1kΩ, T_A = -40°C to +85°C, unless otherwise noted. Typical values are at T_A = +25°C.) (Note 4)

PARAMETER	CONDITIONS		MIN	TYP	MAX	UNITS
Supply Voltage Range			2.75		5.50	V
Switch On-Resistance	V _{IN-} = V _{CC} = 5V, T _A = +25°C		60			mΩ
	V _{IN-} = V _{CC} = 3V, T _A = +25°C		80			
	V _{IN-} = V _{CC} = 5V, T _A = -40°C to +85°C		30		100	
IN Standby Supply Current	V _{ON-} = 0V			3	7.5	μA
IN Quiescent Supply Current	I _{OUT-} = 0A	V _{ONA} = 5V, V _{ONB} = V _{ONC} = 0V		40	80	μA
		V _{ONA} = V _{ONB} = 5V, V _{ONC} = 0V		55	100	
		V _{ONA} = V _{ONB} = V _{ONC} = 5V		60	120	
OUT ₋ Off-Leakage Current	V _{ON-} = 0V, V _{OUT-} = 0V			0.02	10	μA
Undervoltage-Lockout Threshold	V _{IN-} rising, 3% hysteresis		2.2	2.5	2.7	V
Continuous Load Current			1.2			A
Current-Limit Threshold	R _{SET1} = 26.1kΩ		1.20	1.37	1.54	A
	R _{SET1} = 39.2kΩ		0.79	0.91	1.03	
	R _{SET1} = 60.4kΩ		0.49	0.59	0.68	
Short-Circuit Current Limit (Peak Amps)	V _{OUT-} = 0V	R _{SET1} = 26.1kΩ	1.46	1.8	2.20	A
		R _{SET1} = 39.2kΩ	1.2			
		R _{SET1} = 60.4kΩ	0.77			
Short-Circuit Current Limit (RMS Amps)	V _{OUT-} = 0V	R _{SET1} = 26.1kΩ	0.55		A(RMS)	
		R _{SET1} = 39.2kΩ	0.37			
		R _{SET1} = 60.4kΩ	0.23			
Short-Circuit/Continuous Current-Limit Transition Output Voltage Threshold	(Note 5)			1		V

Triple 1.2A USB Switch in 4mm x 4mm Thin QFN

MAX1564

ELECTRICAL CHARACTERISTICS (continued)

($V_{IN_} = V_{CC} = V_{SEL} = V_{ON_} = 5V$, $R_{SET1} = 26.1k\Omega$, $T_A = -40^\circ C$ to $+85^\circ C$, unless otherwise noted. Typical values are at $T_A = +25^\circ C$.) (Note 4)

PARAMETER	CONDITIONS	MIN	TYP	MAX	UNITS
Current-Limit Fault-Blanking Timeout Period	From current-limit condition to $\overline{FLT_}$ low	10	20	40	ms
Turn-On Delay	$R_{OUT_} = 10\Omega$, $C_{OUT_} = 1\mu F$, measured from $ON_$ high to 10% of $V_{OUT_}$	0.5	1.5	4.0	ms
Output Rise Time	$R_{OUT_} = 10\Omega$, $C_{OUT_} = 1\mu F$, measured from 10% to 90% of $V_{OUT_}$		3.5		ms
Turn-Off Delay Time	$R_{OUT_} = 10\Omega$, $C_{OUT_} = 1\mu F$, measured from $ON_$ low to 90% of $V_{OUT_}$		100	1000	μs
Output Fall Time	$R_{OUT_} = 10\Omega$, $C_{OUT_} = 1\mu F$, measured from 90% to 10% of $V_{OUT_}$		4.0		ms
Thermal Shutdown Threshold	10°C hysteresis		+160		°C
Logic-Input High Voltage (ONA, ONB, ONC, SEL)	$V_{IN_} = 2.7V$ to 4.0V	1.6			V
	$V_{IN_} = 4.0V$ to 5.5V	2.0			
Logic-Input Low Voltage (ONA, ONB, ONC, SEL)	$V_{IN_} = 2.7V$ to 4.0V			0.6	V
	$V_{IN_} = 4.0V$ to 5.5V			0.8	
Logic-Input Current		-1		+1	μA
$\overline{FLT_}$ Output Low Voltage	$I_{SINK} = 1mA$			0.4	V
$\overline{FLT_}$ Output High Leakage Current	$V_{FLT_} = 5.5V$			1	μA
SET1 Output Voltage			600		mV
SET1 External Resistor Range	26.1k Ω sets 1.37A maximum current limit	26		60	k Ω
OUT_ Auto-Restart Current	In latched-off state, $V_{OUT_} = 0V$	10	25	50	mA
OUT_ Auto-Restart Threshold	In latched-off state, $V_{OUT_}$ rising	0.4	0.5	0.6	V
OUT_ Auto-Restart Delay Time	In latched-off state, $V_{OUT_} > 1V$	10	20	40	ms
Reverse Current Detection Threshold			0.9		A
Reverse Current Detection Blank Time		10	20	40	ms

Note 4: Specifications to $-40^\circ C$ are guaranteed by design and characterization and not production tested.

Note 5: The output voltage at which the device transitions from short-circuit current limit to continuous current limit.

Triple 1.2A USB Switch in 4mm x 4mm Thin QFN

Typical Operating Characteristics

(Circuit of Figure 1, $V_{INA} = V_{INB} = V_{INC} = V_{SEL} = V_{ONA} = V_{ONB} = V_{ONC} = 5V$, $T_A = +25^\circ C$, unless otherwise noted.)

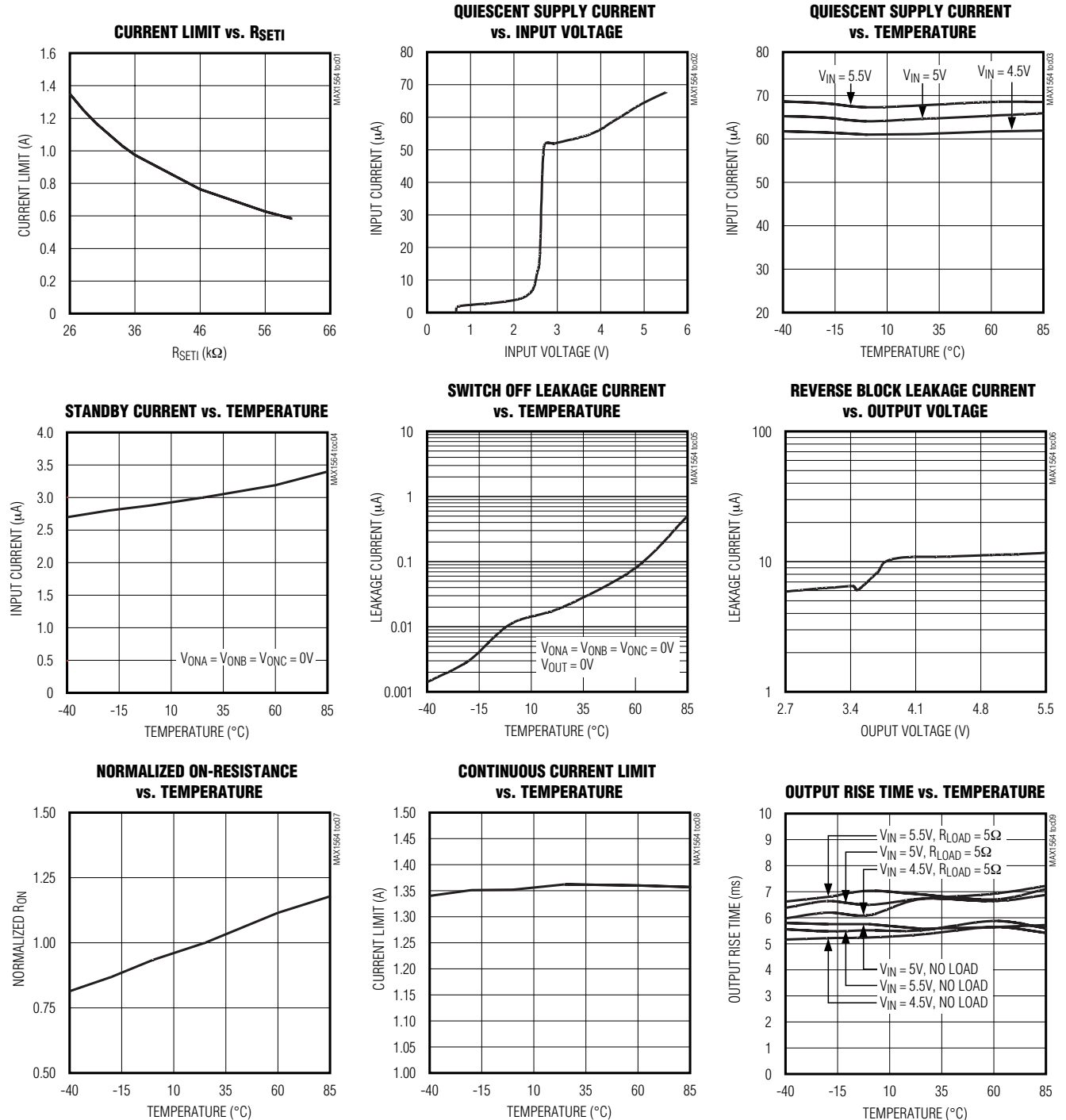

Triple 1.2A USB Switch in 4mm x 4mm Thin QFN

MAX1564

Typical Operating Characteristics (continued)

(Circuit of Figure 1, $V_{INA} = V_{INB} = V_{INC} = V_{SEL} = V_{ONA} = V_{ONB} = V_{ONC} = 5V$, $T_A = +25^\circ C$, unless otherwise noted.)

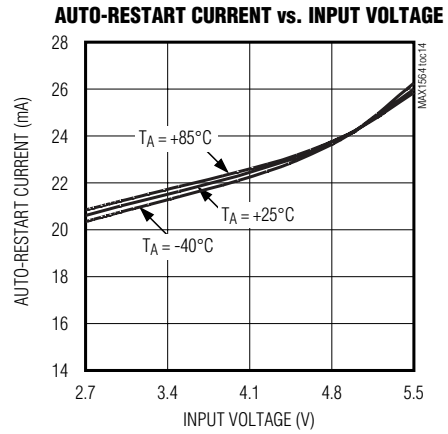
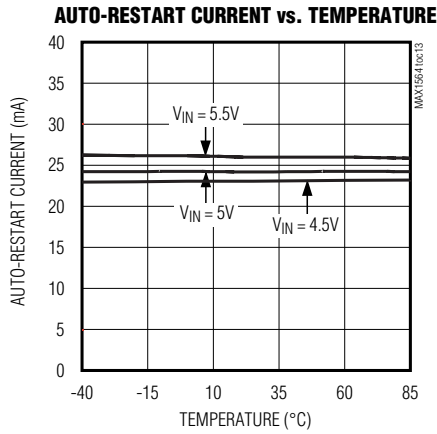
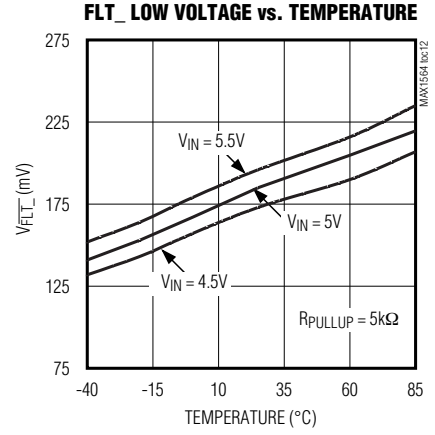
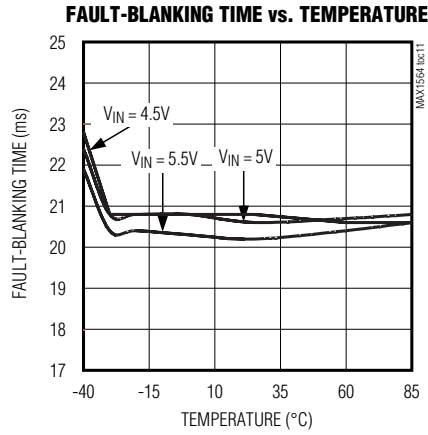
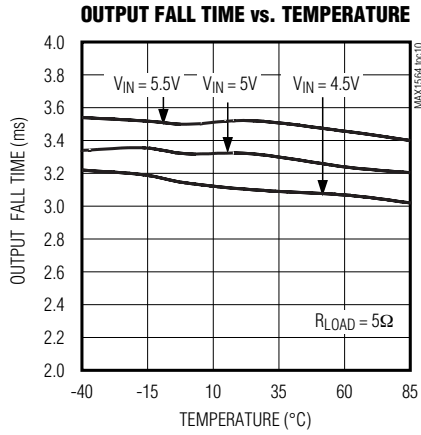

Triple 1.2A USB Switch in 4mm x 4mm Thin QFN

Typical Operating Characteristics (continued)

(Circuit of Figure 1, $V_{INA} = V_{INB} = V_{INC} = V_{SEL} = V_{ONA} = V_{ONB} = V_{ONC} = 5V$, $T_A = +25^\circ C$, unless otherwise noted.)

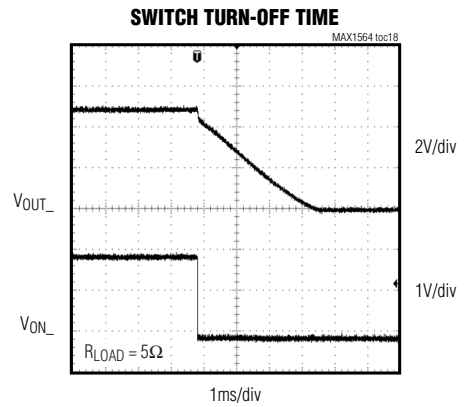
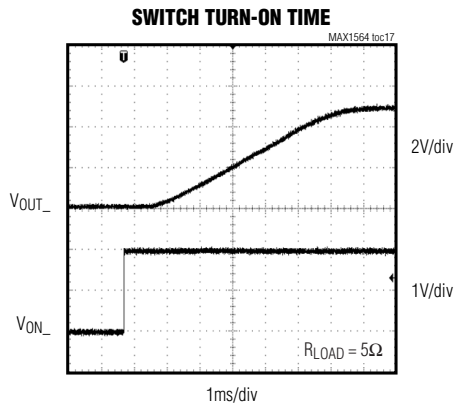
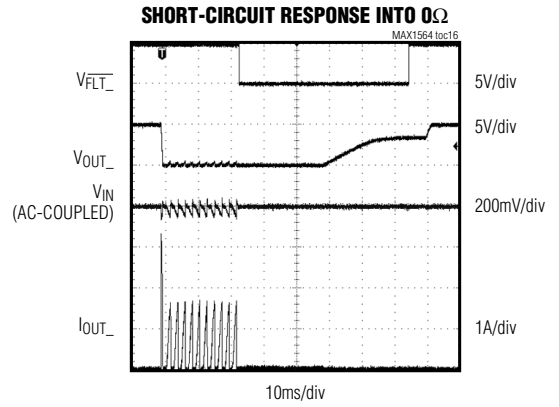
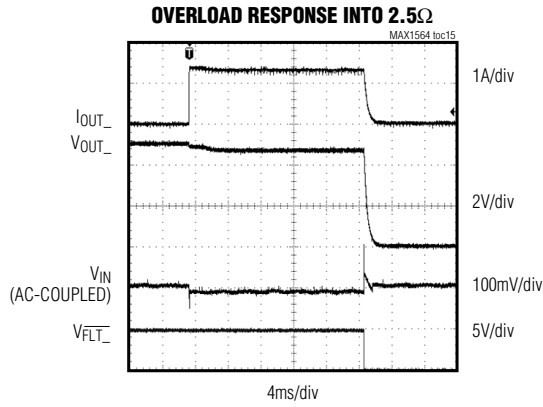

Triple 1.2A USB Switch in 4mm x 4mm Thin QFN

MAX1564

Pin Description

PIN	NAME	FUNCTION
1	INA	Input Power Supply for OUTA. Provides power to OUTA. INA, INB, INC, and V _{CC} must be connected together externally. Bypass with a 0.1µF capacitor to GND. Additional capacitors can be used as required.
2	V _{CC}	Input Power Supply for the MAX1564. Provides power to the IC. INA, INB, INC, and V _{CC} must be connected together externally.
3	INB	Input Power Supply for OUTB. Provides power to OUTB. INA, INB, INC, and V _{CC} must be connected together externally.
4	INC	Input Power Supply for OUTC. Provides power to OUTC. INA, INB, INC, and V _{CC} must be connected together externally.
5	SEL	Polarity Control Input. Selects the polarity of ONA, ONB, and ONC. Connect to V _{CC} for active-high ON_ inputs. Connect to GND for active-low ON_ inputs.
6	SETI	Current-Limit Program Input. Connect a resistor from SETI to GND in the 26kΩ to 60kΩ range. $I_{LIM} = 1.37A \times 26.1k\Omega / R_{SETI}$.
7	$\overline{FLT_B}$	Fault-Indicator Output for Switch B. $\overline{FLT_B}$ is an open-drain output that goes low when INB is below the UVLO threshold, or when switch B is in current limit for greater than 20ms, or when switch B is in thermal shutdown.
8	$\overline{FLT_C}$	Fault Indicator Output for Switch C. $\overline{FLT_C}$ is an open-drain output that goes low when INC is below the UVLO threshold, or when switch C is in current limit for greater than 20ms, or when switch C is in thermal shutdown.
9	OUTC	Power Output for Switch C. OUTC is high impedance during shutdown.
10	OUTB	Power Output for Switch B. OUTB is high impedance during shutdown.
11	GND	Ground. Connect ground to the exposed pad directly under the IC.
12	OUTA	Power Output for Switch A. OUTA is high impedance during shutdown.
13	$\overline{FLT_A}$	Fault Indicator Output for Switch A. $\overline{FLT_A}$ is an open-drain output that goes low when INA is below the UVLO threshold, or when switch A is in current limit for greater than 20ms, or when switch A is in thermal shutdown.
14	ONC	Control Input for Switch C. ONC is active high when SEL is connected to V _{CC} and active low when SEL is connected to GND.
15	ONB	Control Input for Switch B. ONB is active high when SEL is connected to V _{CC} and active low when SEL is connected to GND.
16	ONA	Control Input for Switch A. ONA is active high when SEL is connected to V _{CC} and active low when SEL is connected to GND.
—	EP	Exposed Pad. Connect exposed pad to a large ground plane to improve thermal power dissipation.

Detailed Description

Undervoltage Lockout (UVLO) and Input Voltage Requirements

The MAX1564 includes undervoltage-lockout (UVLO) circuitry to prevent erroneous switch operation when the input voltage is low during startup and brownout conditions. The IC is disabled when the input voltage is

less than 2.5V (typ). \overline{FLT}_- asserts low during a UVLO condition.

Current-Limit Fault Protection

The MAX1564 uses two methods to protect the circuit from overcurrent conditions. During an overcurrent event, the IC senses the switch output voltage and selects either continuous current limiting or short-circuit

Triple 1.2A USB Switch in 4mm x 4mm Thin QFN

current limiting. When $V_{OUT_}$ is greater than 1V, the device operates in continuous current-limit mode and limits output current to a user-programmable level. When $V_{OUT_}$ is less than 1V, the device operates in short-circuit current-limit mode and pulses the output current to levels that are 30% (typ) higher than the selected current limit. When either fault condition persists for 20ms (typ), the output turns off and its fault flag is asserted. The output automatically restarts 20ms after the short or overload is removed.

Auto-Restart Mode

The MAX1564 detects short-circuit removal by sourcing 25mA from the output and monitoring the output voltage. When the voltage at the output exceeds 0.5V for 20ms, the fault flag resets, the output turns back on, and the 25mA current source turns off. Active loads are not expected to draw measurable current when supplied with less than 0.5V. The MAX1564 can also be reset from a fault by toggling the $ON_$ input for the offending channel.

Reverse Current Blocking

The USB specification does not allow an output device to source current back into the USB port. However, the MAX1564 is designed to safely power noncompliant devices. During normal operation with the channel enabled, the IC immediately turns off the switch if the output voltage rises above the input voltage sufficiently to create a reverse current in excess of 0.9A (typ). If the output voltage condition persists for longer than 20ms (typ), the switch remains off and the $\overline{FLT_}$ flag is asserted. When any channel is disabled, the output is switched to a high-impedance state, blocking reverse current flow from the output back to the input.

Thermal Shutdown

Independent thermal shutdown of each channel permits delivering power to normal loads even if one load has a fault condition. The thermal limit does not have the 20ms fault blanking but sets the same fault latch that is used for other faults. Exiting this latched state is described in the *Auto-Restart Mode* section.

Fault Indicators and Fault Blanking

The MAX1564 provides an independent open-drain fault output ($\overline{FLT_}$) for each switch. Connect $\overline{FLT_}$ to $IN_$ through a 100k Ω pullup resistor for most applications. $\overline{FLT_}$ asserts low when any of the following conditions occur:

- The input voltage is below the UVLO threshold.
- The switch junction temperature exceeds the +160°C thermal-shutdown temperature limit.

- The switch is in current-limit or short-circuit current-limit mode after the fault-blanking period (20ms typ) expires.
- The reverse current condition exists after the fault-blanking period expires.

The $\overline{FLT_}$ output goes high impedance after a 20ms delay once the fault condition is removed. Ensure that the MAX1564 input bypass capacitance prevents glitches from triggering the $\overline{FLT_}$ outputs. To differentiate large capacitive loads from short circuits or sustained overloads, the MAX1564 has an independent fault-blanking circuit for each switch. When a load transient causes the output to enter current limit, an internal counter monitors the duration of the fault. For load faults exceeding the 20ms fault-blanking time, the switch turns off, $\overline{FLT_}$ asserts low, and the output enters auto-restart mode (see the *Current-Limit Fault Protection* and *Auto-Restart Mode* sections). Only current-limit and short-circuit faults are blanked. Thermal-overload faults and input voltages below the UVLO threshold immediately turn off the offending output and assert $\overline{FLT_}$ low.

Fault blanking allows the MAX1564 to handle USB loads that might not be fully compliant with USB specifications. The MAX1564 successfully powers USB

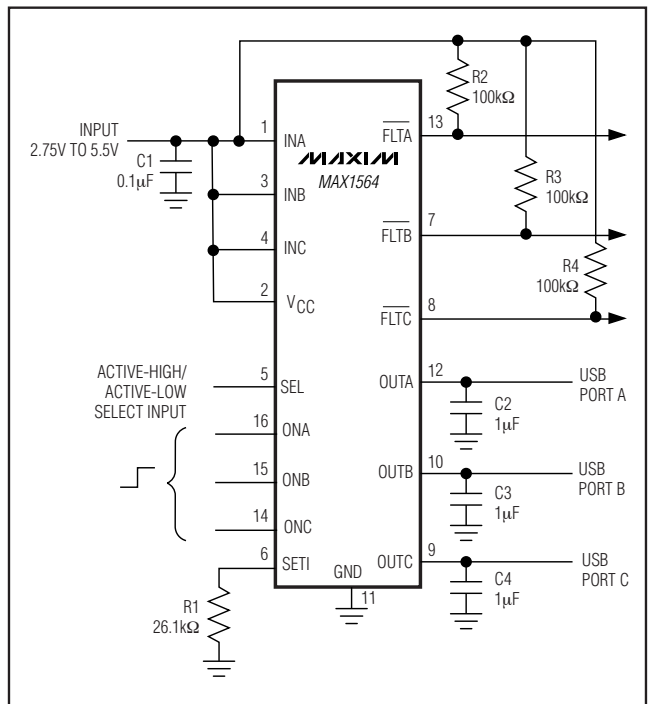

Figure 1. Typical Application Circuit

Triple 1.2A USB Switch in 4mm x 4mm Thin QFN

loads with additional bypass capacitance and/or large startup currents while protecting the upstream power source. No fault is reported if the output voltage rises nominal within the 20ms blanking period.

Applications Information

Setting the Current Limit

The current limit for the MAX1564 is user programmable using the SETI input. Connect a resistor from SETI to GND (R1) to set the current limit. The value for R1 is calculated as:

$$I_{LIMIT} = 1.37A \times 26.1k\Omega / R1$$

R1 must be between 26kΩ and 60kΩ.

Input Capacitor

To limit the input voltage drop during momentary output load transients, connect a capacitor from IN₋ to ground. A 0.1μF ceramic capacitor is required for local decoupling; however, higher capacitor values further reduce the voltage drop at the input. When driving inductive loads, a larger capacitance prevents voltage spikes from exceeding the MAX1564's absolute maximum ratings.

Output Capacitor

A capacitor as large as 2000μF may be used on the output to smooth out transients and/or increase rise/fall times. Larger output capacitance may be used, but the resulting output charge time during startup may exceed the fault blanking period, resulting in a FLT₋ flag.

Driving Inductive Loads

A wide variety of devices (mice, keyboards, cameras, and printers) typically connect to the USB port with cables, adding an inductive component to the load. This inductance causes the output voltage at the USB port to oscillate during a load step. The MAX1564 drives inductive loads; however, care must be taken to avoid exceeding the device's absolute maximum ratings. Usually, the load inductance is relatively small, and the MAX1564's input includes a substantial bulk capacitance from an upstream regulator, as well as local bypass capacitors, limiting overshoot. If severe ringing occurs because of large load inductance, clamp the MAX1564 outputs below +6V and above -0.3V.

Turn-On and Turn-Off Behavior

Slow turn-on and turn-off under normal operating conditions minimizes loading transients on the upstream power source. Rapid turn-off under fault conditions (thermal, short circuit, and UVLO) is done for maximum safety.

Table 1. SEL/ON₋ Inputs

SEL	ON ₋	OUT ₋ STATE
High	High	Enabled
High	Low	Disabled
Low	High	Disabled
Low	Low	Enabled

SEL sets the active polarity of the logic inputs of the MAX1564. Connect ON₋ to the same voltage as SEL to enable the respective OUT₋ switch. Connect ON₋ to the opposite voltage as SEL to disable the respective output (see Table 1). The output of a disabled switch enters a high-impedance state.

Layout and Thermal Dissipation

Keep all input/output traces as short as possible to reduce the effect of undesirable parasitic inductance and optimize the switch response time to output short-circuit conditions. Place input and output capacitors no more than 5mm from device leads. Connect IN₋ and OUT₋ to the power bus with short traces. Wide power bus planes at IN₋ and OUT₋ provide superior heat dissipation as well. An active switch dissipates little power with minimal change in package temperature. Calculate the power dissipation for this condition as follows:

$$P = I_{OUT_}^2 \times R_{ON}$$

At the normal operating current (I_{OUT₋} = 0.5A) and the maximum on-resistance of the switch (100mΩ), the power dissipation is:

$$P = (0.5A)^2 \times 0.100\Omega = 25mW \text{ per switch}$$

The worst-case power dissipation occurs when the output current is just below the current-limit threshold with an output voltage greater than 1V. In this case, the power dissipated in each switch is the voltage drop across the switch multiplied by the current limit:

$$P = I_{LIM} \times (V_{IN} - V_{OUT})$$

For a 5.5V input and 1V output, the maximum power dissipation per switch is:

$$P = 1.54A \times (5.5V - 1V) = 6.9W$$

Because the package power dissipation is 1349mW, the MAX1564 die temperature may exceed the +160°C thermal-shutdown threshold, in which case the switch output shuts down until the junction temperature cools by 10°C. In a continuous overload condition, this causes a cyclical on/off situation. The duty cycle and period of this situation are strong functions of the ambient temperature and the PC board layout (see the *Thermal Shutdown* section).

Triple 1.2A USB Switch in 4mm x 4mm Thin QFN

If the output current exceeds the current-limit threshold, or the output voltage is pulled below the short-circuit detect threshold, the MAX1564 enters a fault state after 20ms, at which point auto-restart mode is enabled and 25mA is sourced by the output. For a 5V input, OUT_ short circuited to GND, and auto-restart mode active, the power dissipation is as follows:

$$P = 0.025A \times 5V = 0.125W$$

Chip Information

PROCESS: BiCMOS

Package Information

For the latest package outline information and land patterns, go to www.maxim-ic.com/packages. Note that a "+", "#", or "-" in the package code indicates RoHS status only. Package drawings may show a different suffix character, but the drawing pertains to the package regardless of RoHS status.

PACKAGE TYPE	PACKAGE CODE	DOCUMENT NO.
16 TQFN-EP	T1644-4	21-0139

Triple 1.2A USB Switch in 4mm x 4mm Thin QFN

Revision History

REVISION NUMBER	REVISION DATE	DESCRIPTION	PAGES CHANGED
0	4/01	Initial release	—
1	2/10	Removed UL Certification Pending bullet from <i>Features</i> section	1

MAX1564

Maxim cannot assume responsibility for use of any circuitry other than circuitry entirely embodied in a Maxim product. No circuit patent licenses are implied. Maxim reserves the right to change the circuitry and specifications without notice at any time.

Maxim Integrated Products, 120 San Gabriel Drive, Sunnyvale, CA 94086 408-737-7600 _____ 11