

B45196H, Tantalum, MnO2 Tantalum, 150 uF, 20%, 4 V, SMD, Molded, 6032, Height Max = 2.8mm

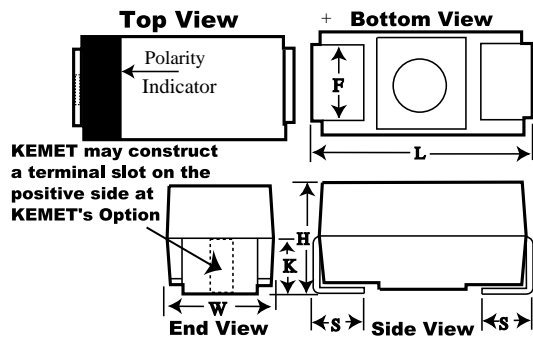

General Information	
Supplier:	KEMET
Series:	B45196H
Dielectric:	MnO2 Tantalum
Style:	SMD Chip
Description:	SMD, Molded
RoHS:	Yes
Termination:	Tin
Notes:	Obsolete. Old Part Number [Obsolete] Was B45196H0157M309

Dimensions	
Footprint	6032
L	6mm +/-0.3mm
W	3.2mm +/-0.3mm
H	2.5mm +/-0.3mm
S	1.3mm +/-0.3mm
F	2.2mm +/-0.1mm
K	1.8mm TYP

Specifications	
Capacitance:	150 uF
Capacitance Tolerance:	20%
Voltage DC:	4 VDC (85C), 2.68 VDC (125C)
Temperature Range:	-55/+125C
Rated Temperature:	85C
Dissipation Factor:	8%
Failure Rate:	N/A
Leakage Current:	6 uA

Packaging Specifications	
Packaging:	T&R, 178mm
Packaging Quantity:	750