

DFRduino M0 Mainboard (Arduino Compatible)

SKU: DFR0392

Introduction

DFRduino M0 is the only Arduino main board that supports 5V standard Logic level and adopts ARM Cortex-M0. [null It is unsatisfactory to make projects with most boards in the market. To be specify,] traditional Arduino UNO is lacking of pins, low-performance... Mega boards are better but too expensive; Arduino ZERO boards are not compatible with 5V power supply device. Luckily, DFRduino M0 is a great soul solves all.

DFRduino M0 selects 32 bytes Nuvoton SCM (Single Chip Mickeyo) of high-performance as the core. Besides built-in ARM Cortex M0 infrastructure, DFRduino M0 supports 5V Logic level, equipped with 1 USB port and 2 serial ports, providing 31 digital pins (parts AFIO) and 6 analog pins, offering more IO resources. Moreover, DFRduino M0 is compatible with Arduino Leonardo package/encapsulation and the clock speed is 72MHz.

Additionally, DFRduino M0 supplies another IIS interface, supporting play & record wav files. Once put DFRduino M0 with advanced IIS chip, professional HIFI audio is available.

NOTE: Different from official Arduino M0, DFRduino M0 adopts a unique chip solution which should be installed independently. It supports Windows, Linux and MAC. The default IDE version should be 1.6.0 and above, other versions should be modified according to FAQ instructions.

Features

- Arduino IDE Compatible
- 32-Bit 72MHz Cortex-M0
- Supports 5V reference voltage
- Supports standard IIS audio interface
- Support USB and dual physical hardware serial port
- Compatible with Leonardo pin packages
- Support wireless programming upload code

Specification

- Microcontrollers: Nuvoton NUC123ZD4AN0 (Cortex M0)
- Clock Speed: 72MHz
- Operating Voltage: 5V
- Recommended Input Voltage: 7-12V
- Limit input voltage: 6-20V
- Digital I/O Pins: 31
- Analog input Pins: 6
- External Interrupt: 4
- SRAM: 20K
- Flash: 68K (of which 12 KB used by bootloader, 55K used by the user code area, 1K used by EEPROM)
- EEPROM: 1K
- SPI: 1 port (D14, D15, D16)
- IIC / I2C: 1 port (D2, D3)
- USB serial port: 1 (Serial)
- Physical serial port: 2 (Serial1, Serial2)
Serial1 0 (Rx1) and 1 (Tx1)
Serial2 24 (Rx2) and 25 (Tx2)
- Xbee interface: 1 (Serial1)
- Size: 68 * 53 mm/ 2.68 * 2.09 inches
- Weight: 30g

Board Overview

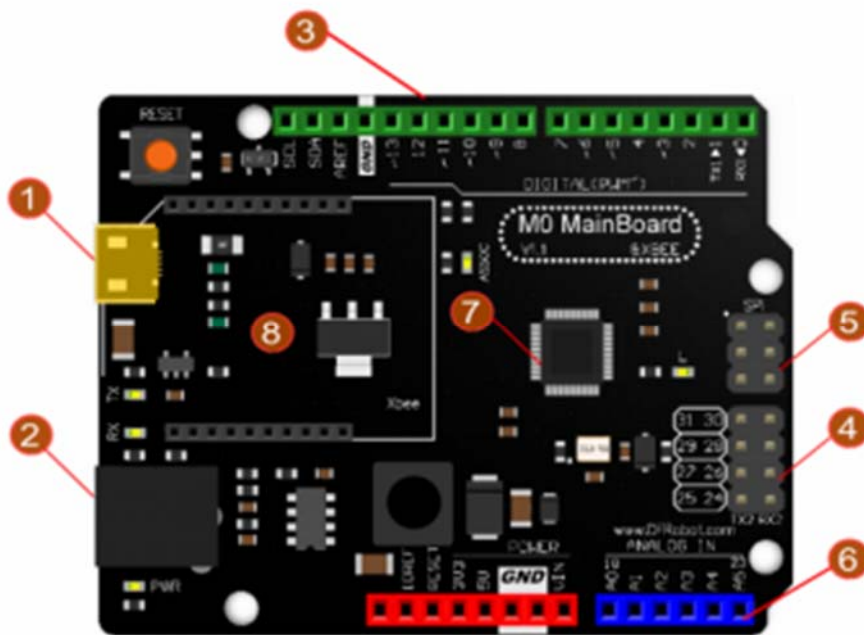

DFRduino M0 Mainboard (Arduino Compatible)

Num	Label	Description
1	USB	USB Power
2	External Power	7~12V
3	Digital IO D0~D13	Digital IO D0~D13 (Leonardo Compatible)
4	Digital IO D24~D31	Digital IO D24~D31
5	SPI Interface	D14, D15, D16 (Pin Multiplexing)
6	Analog A0~A5	Analog A0~A5 (D18~D23 Multiplexing)
7	MCU	NUC123LD4AN0
8	Xbee Socket	Serial1, support wireless programming

PinMap

DFRduino M0 Pins	IC pin	Multiplex	Note
D0	PC4	RXD1	INT2
D1	PC5	TXD1	INT3
D2	PF2	SDA	INT0
D3	PF3	SCL	INT1
D4	PC0	I2S LRCLK	/
D5	PC3	PWM0	/
D6	PA13	PWM1	/
D7	PC2	I2S DI	/
D8	PC3	I2S DO	/
D9	PA14	PWM2	/

D10	PA15	PWM3	/
D11	PB8	PWM4	Software PWM
D12	PC1	I2S BCLK	/
D13	PB14	PWM5	Software PWM
D14	PA10	SPI MISO	/
D15	PA11	SPI SCK	/
D16	PC11	SPI MOSI	/
D17	PB6	RX LED	/
D18	PD0	A0	/
D19	PD1	A1	/
D20	PD2	A2	/
D21	PD3	A3	/
D22	PD4	A4	/
D23	PD5	A5	/
D24	PB4	RXD2	RX2
D25	PB5	TXD2	TX2
D26	PC10	NULL	/
D27	PC9	NULL	/
D28	PC13	NULL	/
D29	PC12	NULL	/
D30	PB9	NULL	/
D31	PB10	NULL	/
D32	PB7	TX LED	/

Tutorial

Requirements

- **Hardware**
DFRduino M0 x 1
Micro USB Cable x1
- **Software**
Arduino IDE (Version requirements: V1.6.X and later), Click to Download Arduino IDE from Arduino®

<https://www.arduino.cc/en/Main/Software%7C>

Setup DFRduino M0 Software Development Environment

- Open Arduino IDE, **File->Preferences**, find **Additional Boards Manager URLs**, copy the below link, and paste in the blank.

https://raw.githubusercontent.com/DFRobot/DFRobotDuinoBoard/master/package_dfrobot_m3_index.json

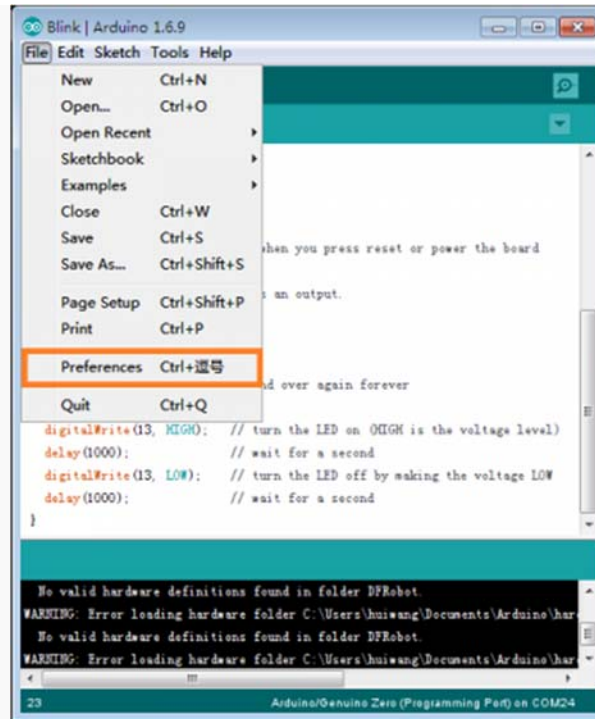

File->Preferences

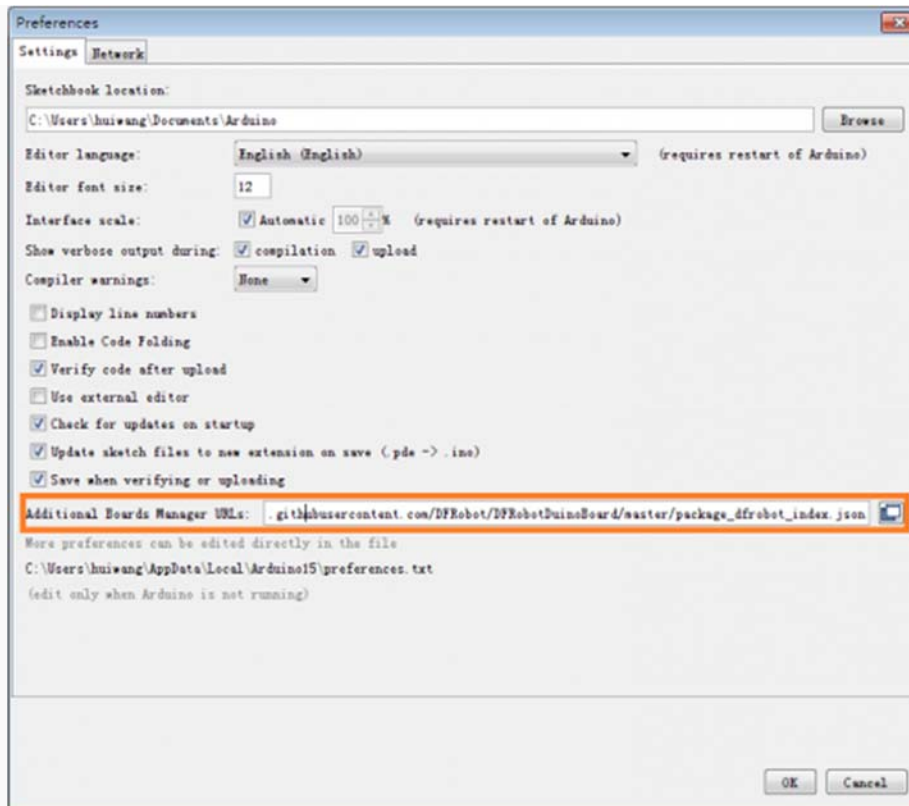

paste url here

- Click **OK**
- Open **Tools->Board->Boards Manager**, enter DFRduino in the search box, click **Install**

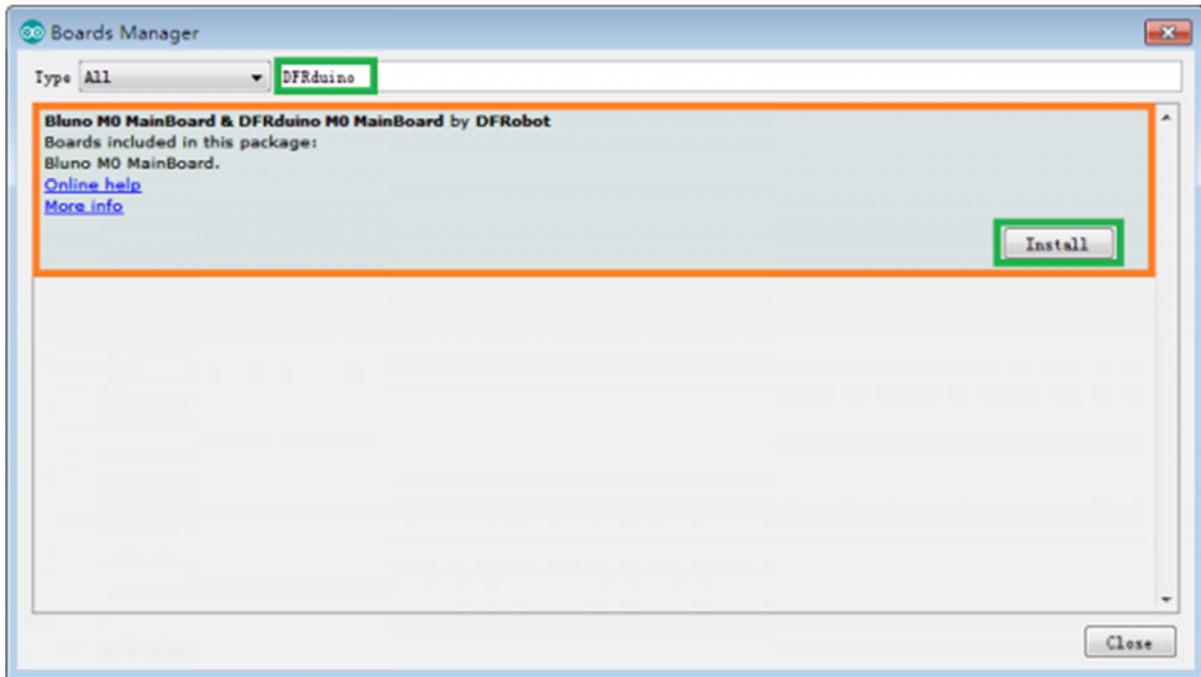

Search "DFRduino M0"

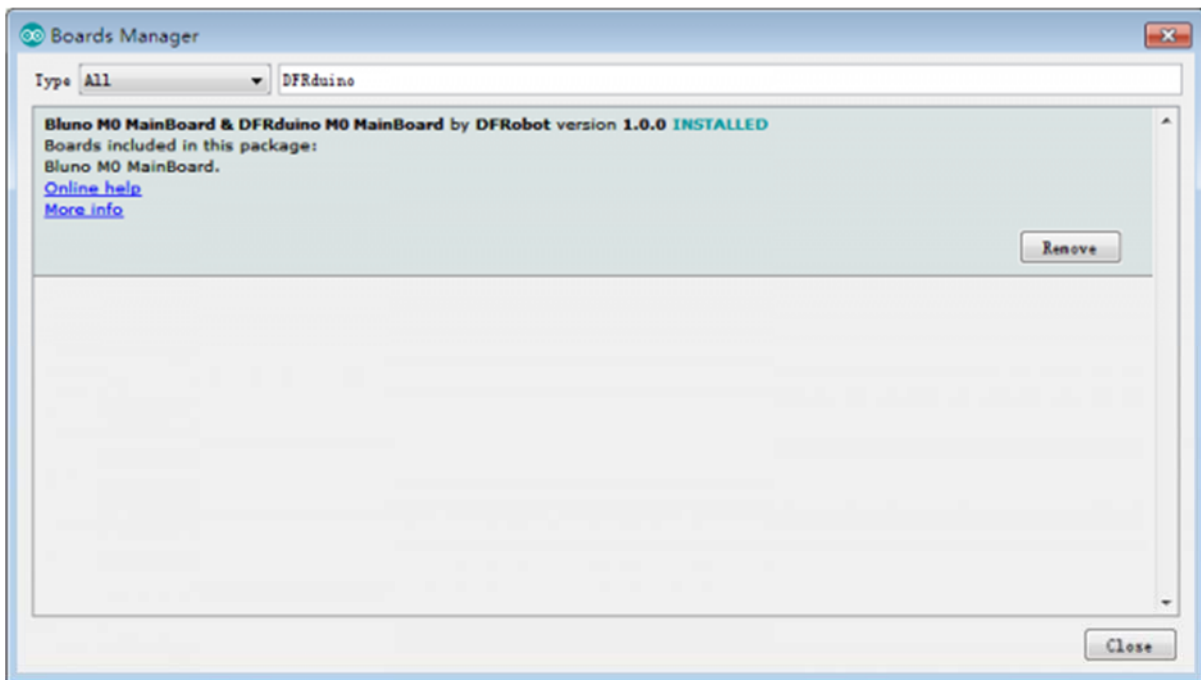

Install DFRduino M0 MainBoard

Now, the development environment has been installed, you can use it like a normal Arduino board.

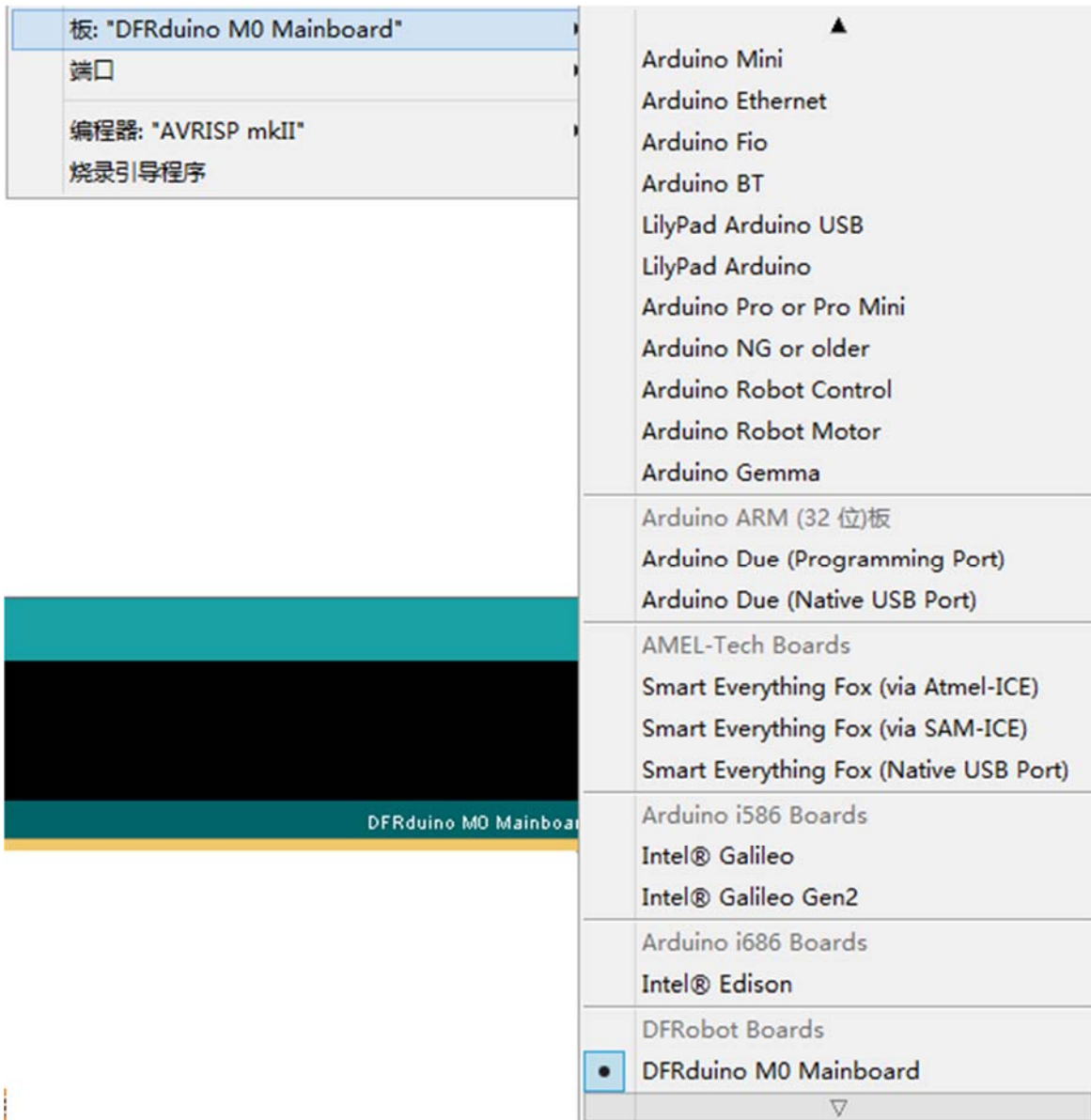

Driver Installation

- Connect M0 to your computer, and you will find an unknown device in the device manager.

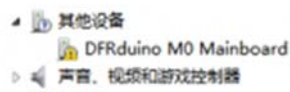

- **Update Driver Software --> Browse my computer for driver software .**
- Generally, this driver is located in the SDK folder
C:\Users\yourUserName\AppData\Local\Arduino15\packages\nucDuino\hardware\nucDuino\1.0.0\driver

- Or you can download it here directly: Click to save. Sometime you need disable the digital signature.

<https://raw.githubusercontent.com/DFRobot/DFRobotDuinoBoard/master/DFRduino%20M0%20MainBoard.inf>

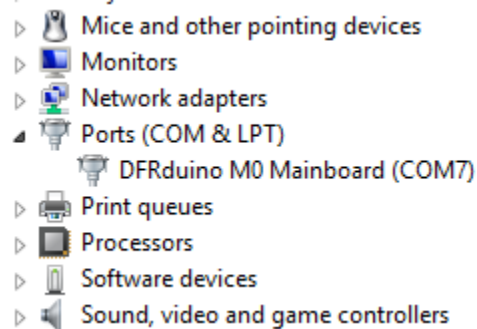

Special Function

Hardware Serial port x2 & USB Serial Port x1

- Just like Arduino Leonardo, M0 has USB Serial Port and Hardware Serial Port.

USB Serial Port	Serial
Hardware Serial Port 1	Serial1
Hardware Serial Port 2	Serial2

- **Sample Code**

```
void setup() { // put your setup code here, to run once:
  Serial.begin(115200);
  while(!Serial);
  Serial1.begin(115200);
  Serial2.begin(115200);
}

void loop() { // put your main code here, to run repeatedly:
  Serial.println("I am USB CDC Serial");
  Serial1.println("I am Serial 1");
```



```
Serial2.println("I am Serial 2");  
delay(1000);  
}
```

- Tested Platform:
Windows: win7 32bit/64bit, win8 32bit/64bit, win10 32bit
Linux: ubuntu 12.04 32bit
Mac book:

FAQ

Q1. No permission under Linux system

A. Input `sudo usermod -a -G USER NAME dialout` to add user into **dialout** group. Log out and log back in

For any questions, advice or cool ideas to share, please visit the [DFRobot Forum](#).