

RONDA-REC-60

~60° 60° rectangular beam with holder A compatible with 3rd party connectors from TE, Bender Wirth and IDEAL

TECHNICAL SPECIFICATIONS:

Dimensions	Ø 69.9 mm
Height	14.6 mm
Fastening	socket
Colour	white
Box size	
Box weight	0 kg
Quantity in Box	420 pcs
ROHS compliant	yes ⓘ

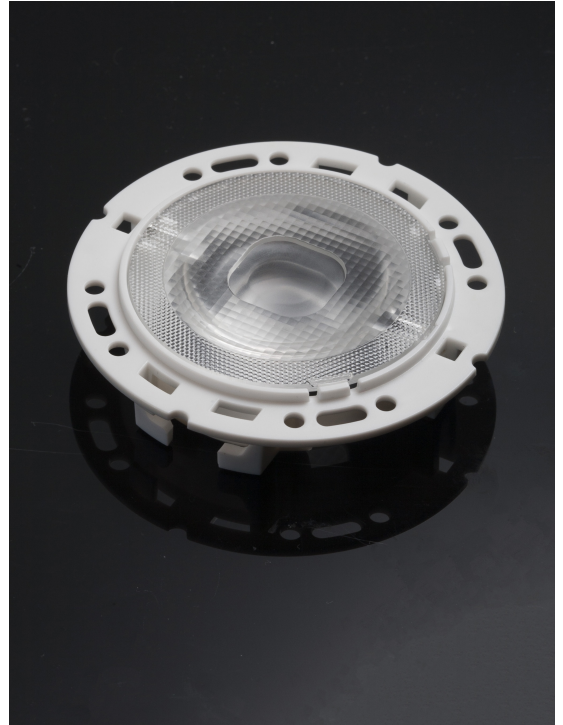





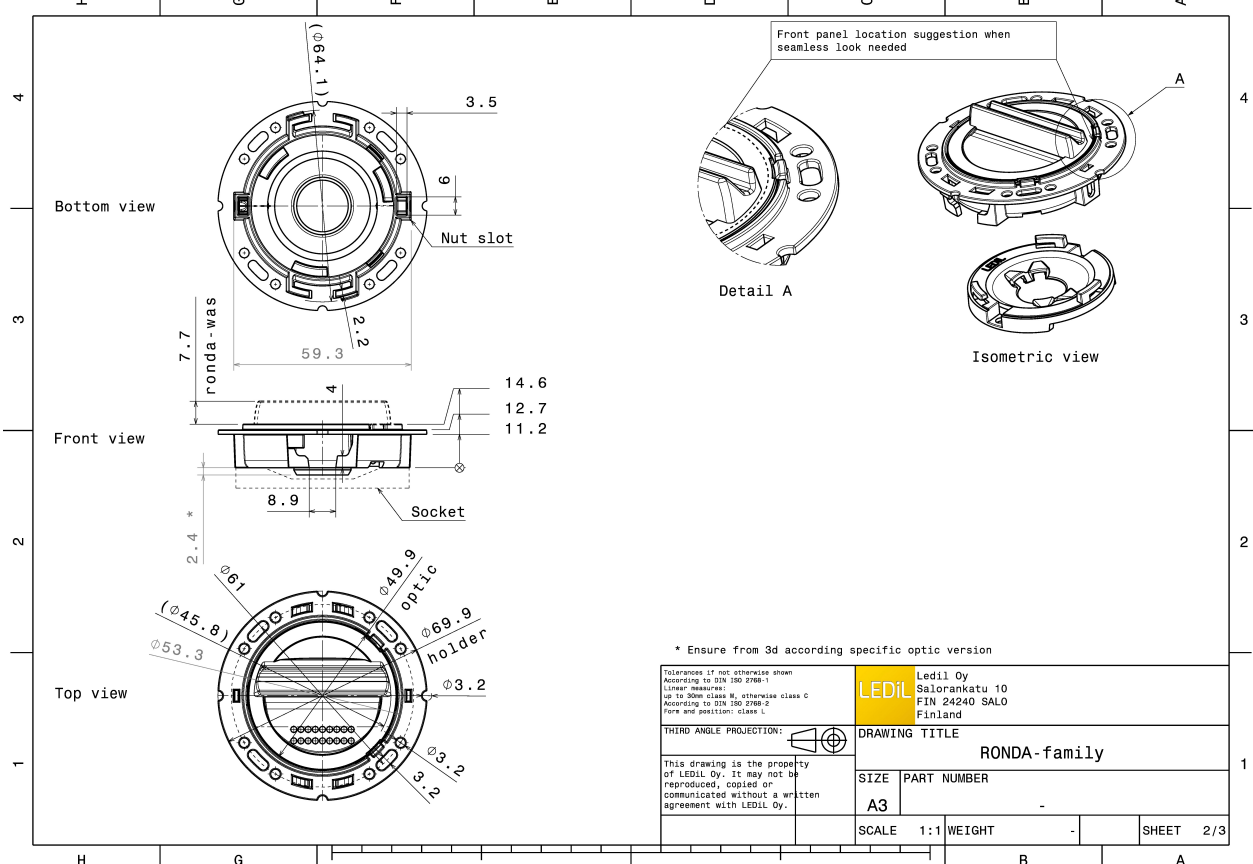
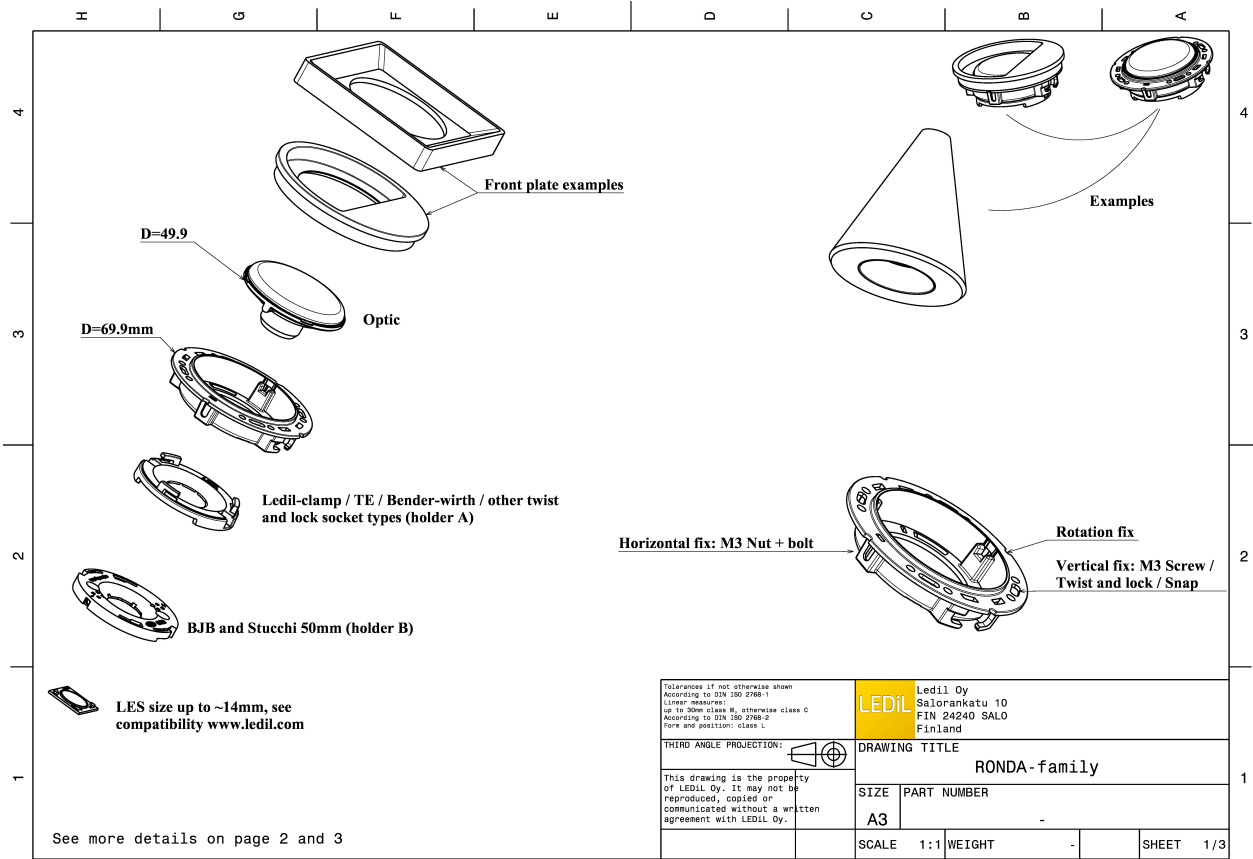

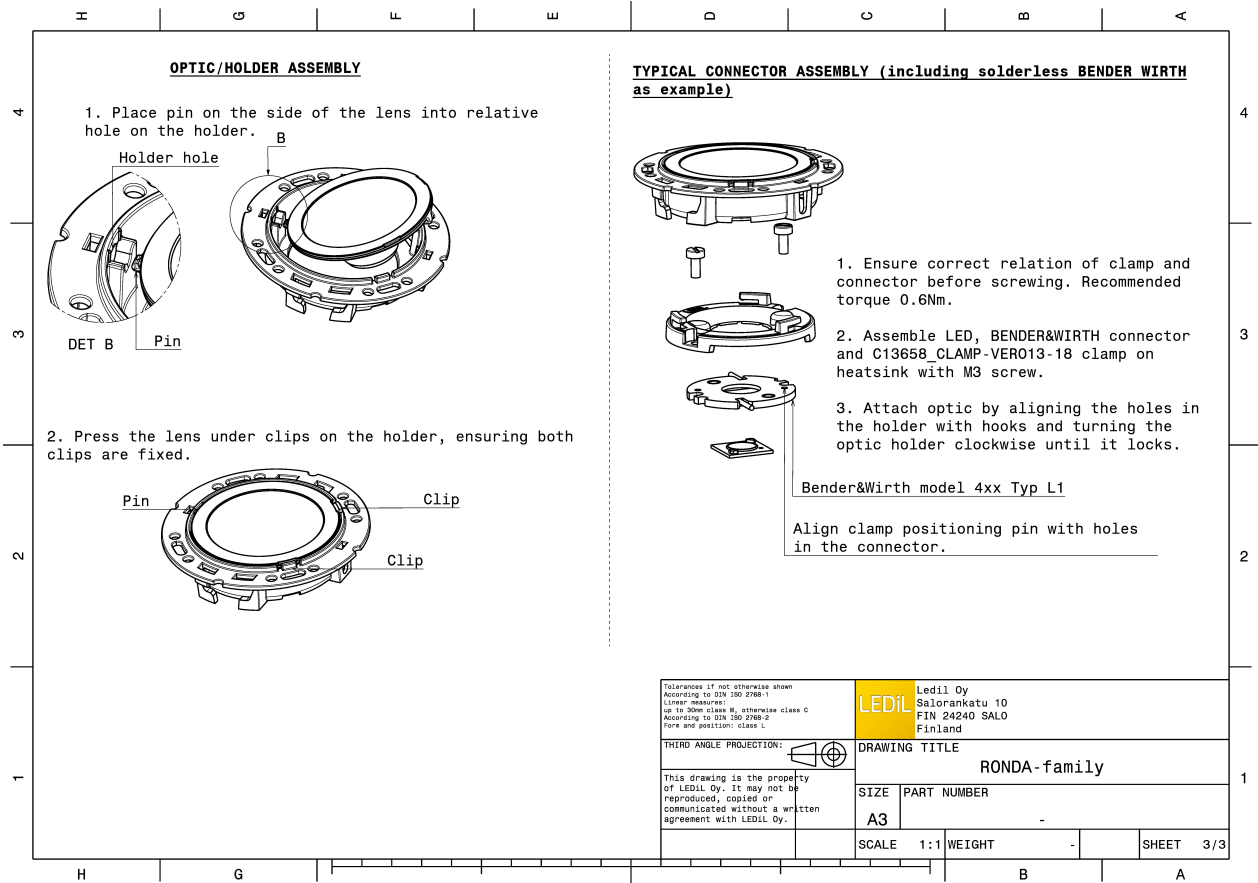

MATERIAL SPECIFICATIONS:

Component	Type	Material	Colour
RONDA-REC-60	Lens	PMMA	clear
RONDA-HLD-A	Holder	PC	white

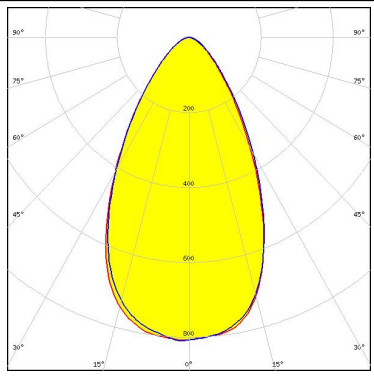

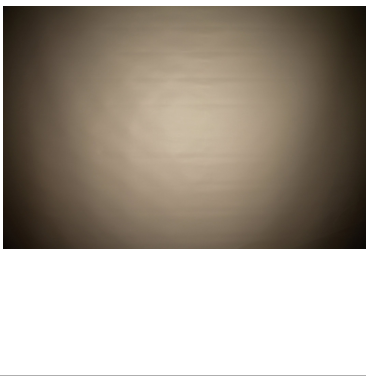
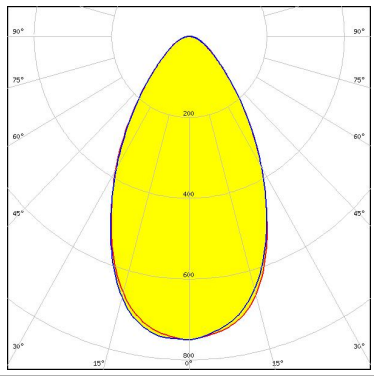

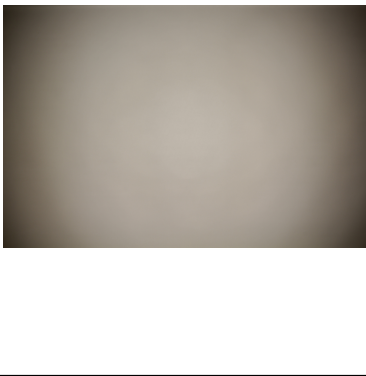
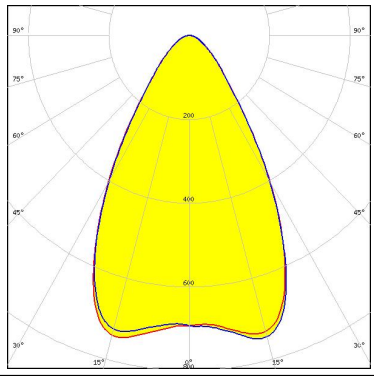
PHOTOMETRIC DATA (MEASURED):

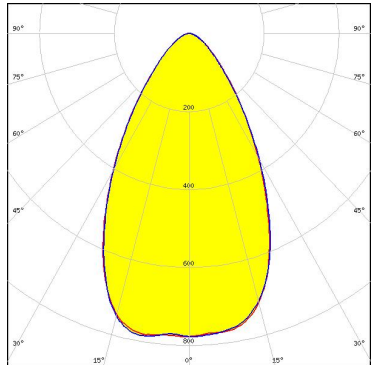
<p> LED: Vero SE 13 FWHM: 58.0° Efficiency: 90 % Peak intensity: 0.800 cd/lm Required components: C16402_CLAMP-VEROSE-13-18</p>		
<p> LED: CMA1840 FWHM: 60.0° Efficiency: 90 % Peak intensity: 0.750 cd/lm Required components: C14123_CLAMP-CXA15-18</p>		
<p> LED: CXA/B 15xx FWHM: 63.0° Efficiency: 91 % Peak intensity: 0.750 cd/lm Required components: C14123_CLAMP-CXA15-18</p>		
<p> LED: CXA/B 1816 & CXA/B 1820 & CXA 1850 FWHM: 60.0° Efficiency: 91 % Peak intensity: 0.800 cd/lm Required components: LEDiL: C14123_CLAMP-CXA15-18</p>		

PHOTOMETRIC DATA (SIMULATED):

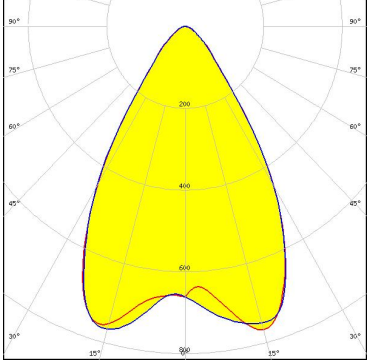
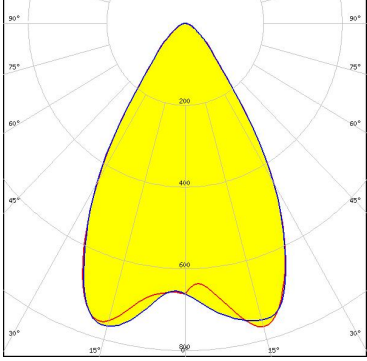
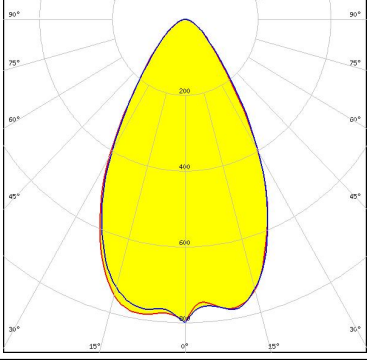
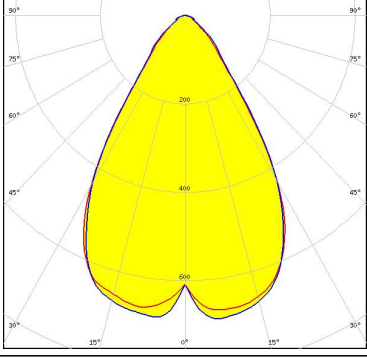
<p>bridgelux.</p> <p>LED H9</p> <p>FWHM 63.0°</p> <p>Efficiency 91 %</p> <p>Peak intensity cd/lm</p> <p>Required components: C14123_CLAMP-CXA15-18</p>	
<p>bridgelux.</p> <p>LED H9</p> <p>FWHM 63.0°</p> <p>Efficiency 91 %</p> <p>Peak intensity cd/lm</p> <p>Required components: C13658_CLAMP-VERO13-18 Bender Wirth: 441 Typ L1</p>	
<p>bridgelux.</p> <p>LED V13 Gen7</p> <p>FWHM 60.0°</p> <p>Efficiency 87 %</p> <p>Peak intensity 0.800 cd/lm</p> <p>Required components: C13658_CLAMP-VERO13-18 Bender Wirth: 477 Typ L1</p>	
<p>CITIZEN</p> <p>LED CLU700/701</p> <p>FWHM 65.0°</p> <p>Efficiency 90 %</p> <p>Peak intensity cd/lm</p> <p>Required components: C13658_CLAMP-VERO13-18 Bender Wirth: 434 Typ L1</p>	

PHOTOMETRIC DATA (SIMULATED):

CITIZEN

LED CLU710/711
FWHM 61.0°
Efficiency 90 %
Peak intensity cd/lm
Required components:
C13658_CLAMP-VERO13-18
Bender Wirth: 470 Typ L1

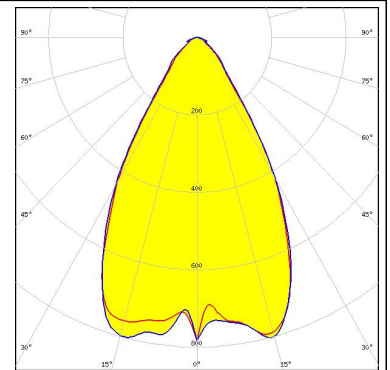

CREE

LED CXA/B 13xx
FWHM 65.0°
Efficiency 90 %
Peak intensity cd/lm
Required components:
C13658_CLAMP-VERO13-18
Bender Wirth: 448 Typ L1

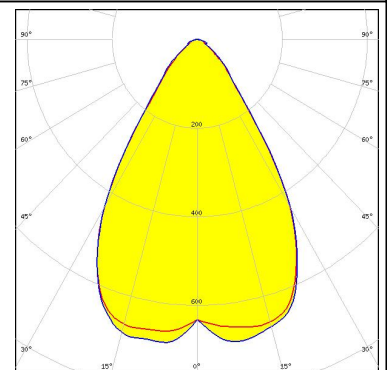

CREE

LED CXA/B 15xx
FWHM 62.0°
Efficiency 89 %
Peak intensity cd/lm
Required components:
C13658_CLAMP-VERO13-18
Bender Wirth: 441 Typ L1

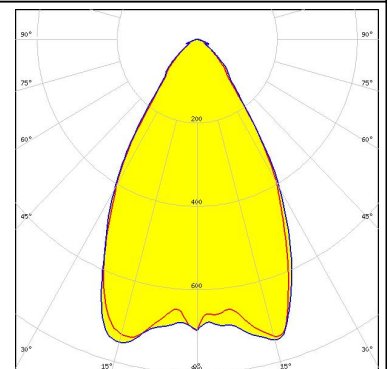

LUMILEDS

LED LUXEON CoB 1202s
FWHM 61.0°
Efficiency 90 %
Peak intensity cd/lm
Required components:
C13658_CLAMP-VERO13-18
Bender Wirth: 452 Typ L1

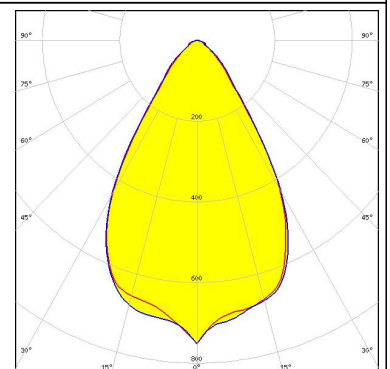

PHOTOMETRIC DATA (SIMULATED):



LED NSCxL036A

FWHM 58.0°

Efficiency 89 %

Peak intensity 0.830 cd/lm

Required components:

TE: 2213382-2 + OPTIC CLIP Z50 TYPE1 2213194-1

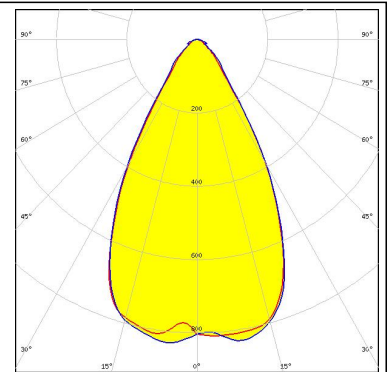

LED Mini Zenigata (GW6BM)

FWHM 60.0°

Efficiency %

Peak intensity cd/lm

Required components:

C13658_CLAMP-VERO13-18

Bender Wirth: 452 Typ L1

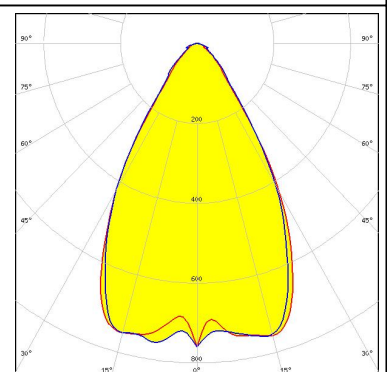

LED SLE G6 LES15

FWHM 51.0°

Efficiency 85 %

Peak intensity 0.980 cd/lm

Required components:

TE: 2213254-2 + OPTIC CLIP Z50 TYPE1 2213194-1

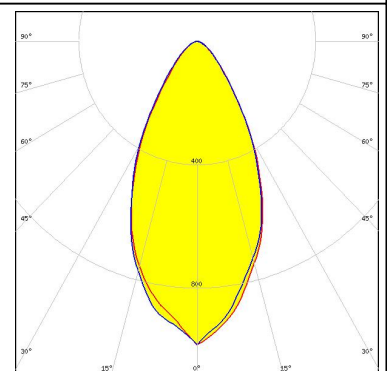

GENERAL INFORMATION:

NOTE: The typical beam angle will be changed by different color, chip size and chip position tolerance. The typical total beam angle is the full angle measured where the luminous intensity is half of the peak value.

Due to use of high power COB's with this product, special attention to proper thermal design is highly recommended. LEDiL has no liability for direct, indirect or consecutive damages arising from the LEDiL products being used outside of the recommended temperature range.

MATERIALS:

As part of our continuous research and improvement processes, and to ensure the best possible quality and availability of our products, LEDiL reserves the right to change material grades without notice.

PRODUCT DATA USER AGREEMENT AND DISCLAIMER:

The measured data in the provided downloadable LEDiL Product Datasheets and Mechanical 2D-Drawings is rounded and provided as reference for planning. LEDiL Oy's optical specifications have been verified by conducting performance testing of the products in accordance with the company's quality system. The reported data are averaged results of multiple measurements with typical variation. LEDiL Oy reserves the right to without prior notification make changes and improvements to its products.

LEDiL Oy assumes neither warranty, nor guarantee nor any other liability of any kind for the contents and correctness of the provided data. The provided data has been generated with highest diligence but the provided data may in reality not represent the complete possible variation range of all intrinsic parameters. Therefore, in certain cases a deviation from the provided data could occur.

LEDiL Oy reserves the right to undertake technical changes of its products without further notification which could lead to changes in the provided data. LEDiL Oy assumes no liability of any kind for the possible deviation from any provided data or any other damage resulting from the usage of the provided data.

The user agrees to this disclaimer and user agreement with the download or usage of the provided files.

LEDiL Oy

Joensuunkatu 13
FI-24240 SALO
Finland

LEDiL Inc.

228 West Page Street
Suite D
Sycamore IL 60178
USA

Local sales and technical support

www.ledil.com/where_to_buy

Shipping locations

Salo, Finland
Hong Kong, China

Distribution Partners

www.ledil.com/where_to_buy