

## FEATURES

- High output power: 14 dBm typical
- Input power drive: 0 dBm to 10 dBm
- Single sideband (SSB) phase noise at 100 kHz offset:
  - 142 dBc/Hz
- Output frequency ( $f_{OUT}$ ) isolation
  - 16 dBc at  $f_{OUT} = 15$  GHz
- Hermetically sealed module (HSM)
- SMA field replaceable connectors
- 55°C to +85°C operating temperature

## APPLICATIONS

- Clock generation applications
  - Synchronous optical networking (SONET) optical carrier (OC)-192 and synchronous digital hierarchy (SDH)
  - synchronous transport module (STM)-64
- Point to point and very small aperture terminal (VSAT) radios
- Test instrumentation
- Military electronic warfare and radar
- Space

## GENERAL DESCRIPTION

The **HMC-C056** is a  $\times 2$  active broadband frequency multiplier module, using gallium arsenide (GaAs), pseudomorphic high electron mobility transistor (pHEMT) technology in a miniature HSM. When driven by a 6 dBm signal, the multiplier provides 14 dBm typical output power from 8 GHz to 21 GHz. The  $f_{OUT}$  isolation is 16 dBc at 15 GHz with respect to the output signal level.

## FUNCTIONAL BLOCK DIAGRAM

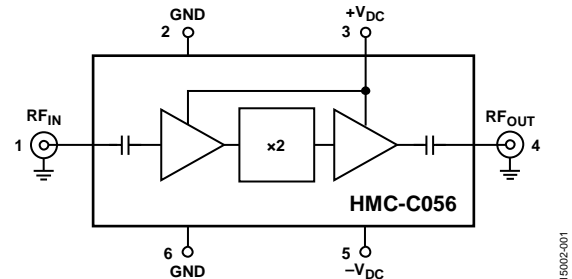

Figure 1.

The **HMC-C056** is a frequency multiplier, featuring dc blocked inputs/outputs. The **HMC-C056** is ideal for use in local oscillator (LO) multiplier chains for point to point and VSAT radios yielding reduced devices count vs. traditional approaches. The low additive SSB phase noise of -142 dBc/Hz at 100 kHz offset has minimal impact on system level noise performance.

## TABLE OF CONTENTS

Features .....	1	ESD Caution.....	4
Applications.....	1	Pin Configuration and Function Descriptions.....	5
Functional Block Diagram .....	1	Interface Schematics .....	5
General Description .....	1	Typical Performance Characteristics .....	6
Revision History .....	2	Outline Dimensions .....	8
Specifications.....	3	Ordering Guide .....	8
Electrical Specifications.....	3		
Absolute Maximum Ratings.....	4		

## REVISION HISTORY

This Hittite Microwave Products data sheet has been reformatted to meet the styles and standards of Analog Devices, Inc.

### 3/2017—Rev. 04.1110 to Rev. D

Updated Format.....	Universal
Changes to Features Section.....	1
Changes to Table 1.....	3
Changes to Table 3.....	5
Updated Outline Dimensions .....	7
Changes to Ordering Guide .....	7

**SPECIFICATIONS****ELECTRICAL SPECIFICATIONS**

$T_A = 25^\circ\text{C}$ ,  $+V_{DC} = 12\text{ V}$ ,  $-V_{DC} = -5\text{ V}$ , radio frequency (RF) input power = 6 dBm, unless otherwise noted.

**Table 1.**

<b>Parameter</b>	<b>Min</b>	<b>Typ</b>	<b>Max</b>	<b>Unit</b>
FREQUENCY RANGE				
Input	4		10.5	GHz
Output	8		21	GHz
OUTPUT POWER, $f_{OUT} = 10\text{ GHz to }20\text{ GHz}$	10	14		dBm
$f_{OUT}$ ISOLATION (WITH RESPECT TO OUTPUT LEVEL)		16		dBc
INPUT POWER DRIVE	0		10	dBm
RETURN LOSS				
Input		14		dB
Output		10		dB
SSB PHASE NOISE (100 kHz OFFSET), $f_{OUT} = 15\text{ GHz}$		-142		dBc/Hz
SUPPLY CURRENT				
$+V_{DC}$		102		mA
$-V_{DC}$		5		mA

## ABSOLUTE MAXIMUM RATINGS

Table 2.

Parameter	Rating
RF Input, $+V_{DC} = 5\text{ V}$	13 dBm
Bias Supply Voltage	
$+V_{DC}$	15 V
$-V_{DC}$	-15 V
Temperature	
Storage	-65°C to +150°C
Operating	-55°C to +85°C

Stresses at or above those listed under Absolute Maximum Ratings may cause permanent damage to the product. This is a stress rating only; functional operation of the product at these or any other conditions above those indicated in the operational section of this specification is not implied. Operation beyond the maximum operating conditions for extended periods may affect product reliability.

### ESD CAUTION



**ESD (electrostatic discharge) sensitive device.** Charged devices and circuit boards can discharge without detection. Although this product features patented or proprietary protection circuitry, damage may occur on devices subjected to high energy ESD. Therefore, proper ESD precautions should be taken to avoid performance degradation or loss of functionality.

## PIN CONFIGURATION AND FUNCTION DESCRIPTIONS

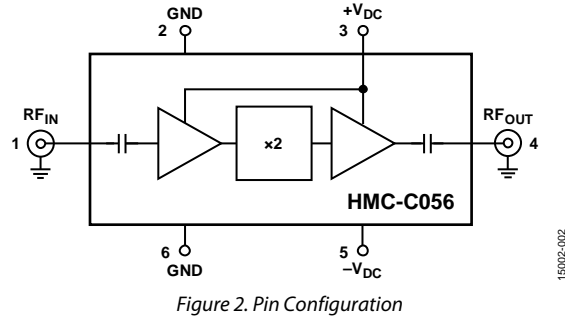

Figure 2. Pin Configuration

Table 3. Pin Function Descriptions

Pin No.	Mnemonic	Description
1	RF <sub>IN</sub>	Radio Frequency Input. This pin is ac-coupled and matched to 50 Ω. RF <sub>IN</sub> uses a female SMA field replaceable connector. RF ground is supplied by the outer conductor of the SMA connector. See Figure 3 for the interface schematic.
2, 6	GND	Ground. One of these pins must be connected to power supply ground. See Figure 4 for the interface schematic.
3	+V <sub>DC</sub>	Positive Power Supply Voltage. Positive power supply voltage for the multiplier includes a linear regulator. See Figure 5 for the interface schematic.
4	RF <sub>OUT</sub>	Radio Frequency Output. This pin is ac-coupled and matched to 50 Ω. RF <sub>OUT</sub> uses a female SMA field replaceable connector. RF ground is supplied by the outer conductor of the SMA connector. See Figure 6 for the interface schematic.
5	-V <sub>DC</sub>	Negative Power Supply Voltage. Negative power supply voltage for the multiplier includes a linear regulator. See Figure 7 for the interface schematic.

## INTERFACE SCHEMATICS

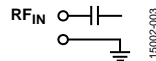

Figure 3. RF<sub>IN</sub> and RF Ground Interface Schematic

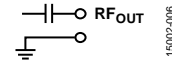

Figure 6. RF<sub>OUT</sub> and RF Ground Interface Schematic



Figure 4. GND Interface Schematic

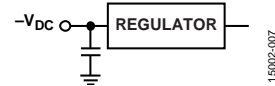

Figure 7. -V<sub>DC</sub> Interface Schematic

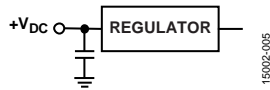

Figure 5. +V<sub>DC</sub> Interface Schematic

TYPICAL PERFORMANCE CHARACTERISTICS

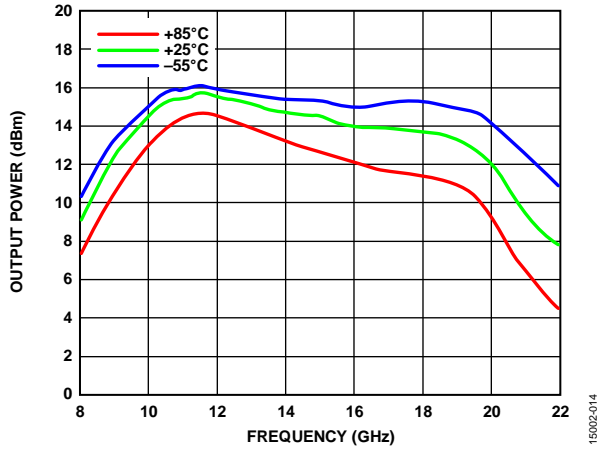

Figure 8. Output Power vs. Frequency at Various Temperatures at 6 dBm Drive Level

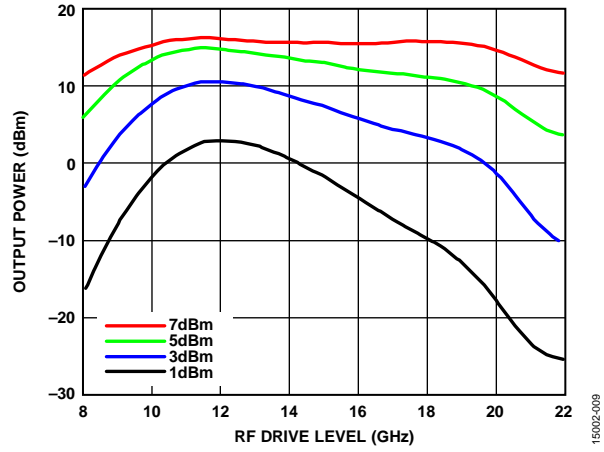

Figure 10. Output Power vs. RF Drive Level

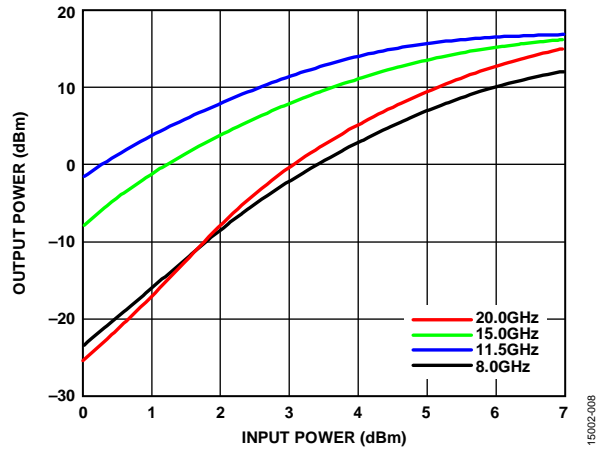

Figure 9. Output Power vs. Input Power

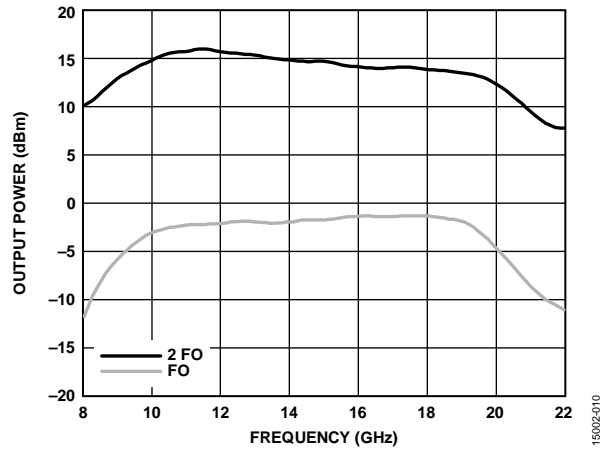

Figure 11. Isolation at 6 dBm Drive Level

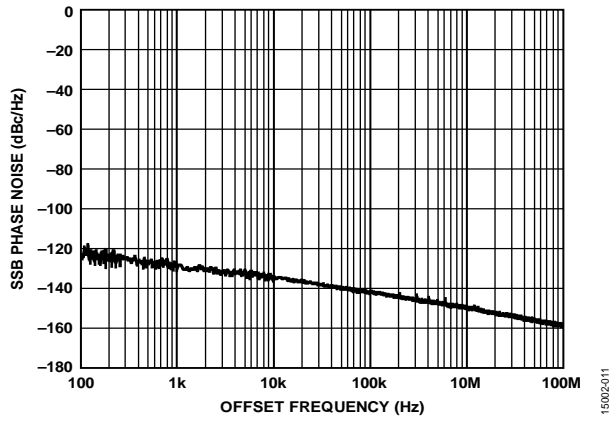

Figure 12. SSB Phase Noise vs. Offset Frequency,  
 $f_{OUT} = 15 \text{ GHz}$ , Input Power = 6 dBm

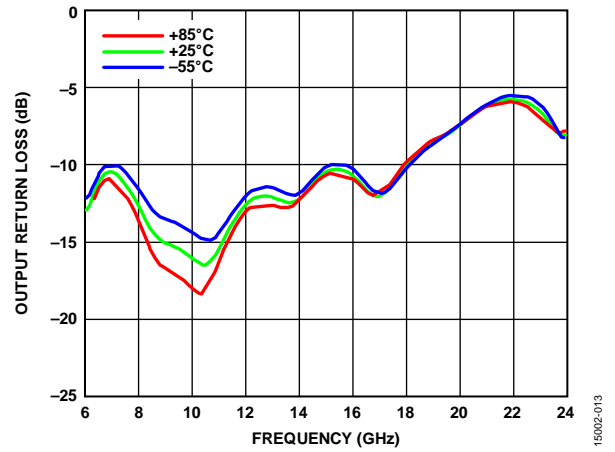

Figure 14. Output Return Loss vs. Frequency at 0 dBm Drive Level

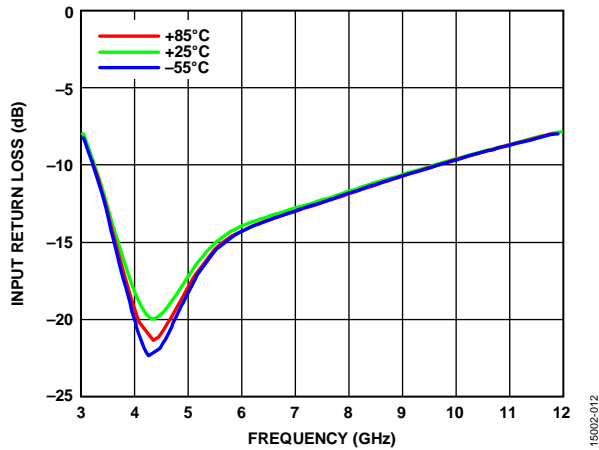
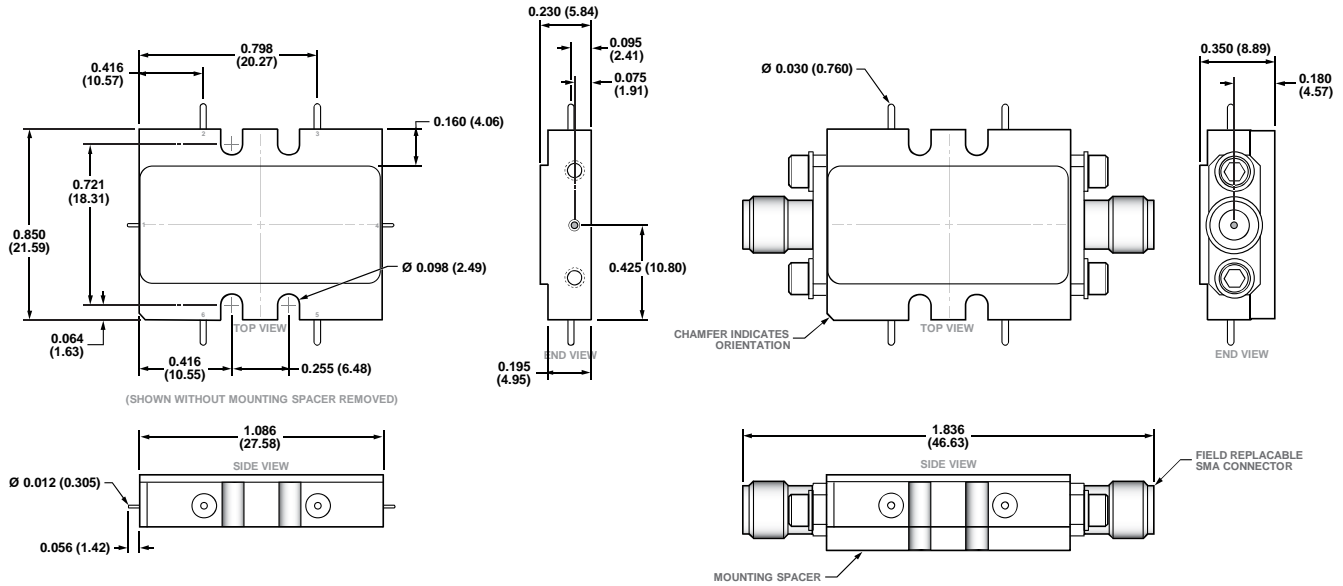

Figure 13. Input Return Loss vs. Frequency at 0 dBm Drive Level

OUTLINE DIMENSIONS



CONTROLLING DIMENSIONS ARE IN INCHES; MILLIMETER DIMENSIONS (IN PARENTHESES) ARE ROUNDED-OFF INCH EQUIVALENTS FOR REFERENCE ONLY AND ARE NOT APPROPRIATE FOR USE IN DESIGN.

Figure 15. 6-Lead Multichip Module Laminate, with Input/Output Connector [MODULE] (HML-6-2)  
Dimensions shown in inches and (millimeters)

ORDERING GUIDE

Model <sup>1</sup>	Temperature Range	Package Description	Package Option
HMC-C056	-55°C to +85°C	6-Lead Multichip Module Laminate, with Input/Output Connector [MODULE]	HML-6-2

<sup>1</sup> The HMC-C056 is a RoHS Compliant Part.