

THIS COPY IS PROVIDED ON A RESTRICTED BASIS AND IS NOT TO BE USED IN ANY WAY DETRIMENTAL TO THE INTERESTS OF PANDUIT CORP.

PANDUIT PART NUMBER	WEIGHT
 WG24FRTB**	5.07 LBS/EACH (2299.7 g/EACH)

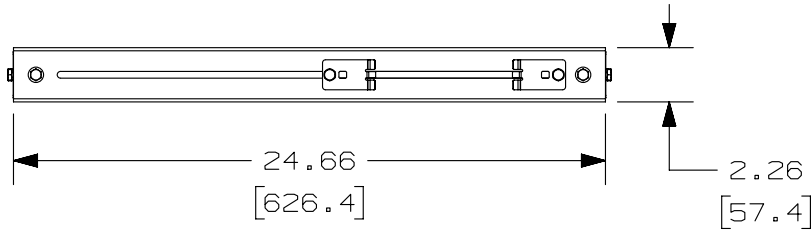

- NOTE:**
- PANDUIT PART NUMBER WG24FRTB** INCLUDES:
 - ONE (1) WYR-GRID 24" WIDTH FIBERRUNNER TRAPEZE BRACKET ASSEMBLY FOR 4X4 AND 6X4.
 - TWO (2) WYR-GRID FIBERRUNNER TRAPEZE UPRIGHT SUPPORT BRACKET ASSEMBLIES.
 - TWO (2) 1/4-20 X 3/4 HEX HEAD CAP SCREWS.
 - FOUR (4) 1/4 -20 HELICAL SPRING LOCKWASHERS.
 - TWO (2) 1/4-20 SAE FLAT WASHER.
 - TWO (2) 1/4-20 X 1-1/8 HEX HEAD CAP SCREWS.
 - TWO (2) WYR-GRID INTEGRAL BRACKET LOWER CLIP ASSEMBLIES.
 - DIMENSIONS IN PARENTHESES ARE METRIC.
 - PROVIDES ABILITY TO MOUNT FIBERRUNNER 6.6" TO 9.9" ABOVE WYR-GRID.
 - SEE CATALOG FOR ADDITIONAL PART SUFFIXES TO INDICATE PART FINISH AND/OR PACKAGE QUANTITY.

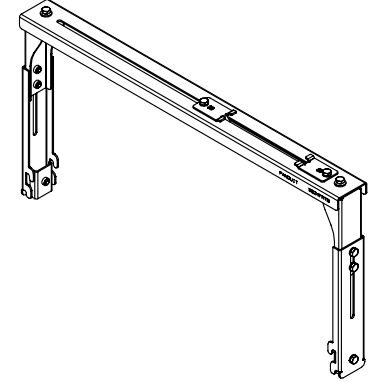
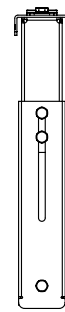
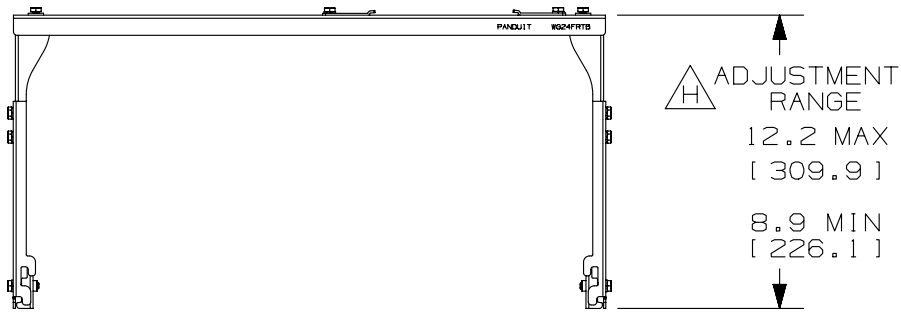

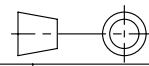

REV	DATE	BY	CHK	APR	DESCRIPTION	ECN
4	09-06-13	SSP	KMC	RN	I. REVISED INTEFRAL TO INTEGRAL ON NOTE 1.G	10D166AH-DC
3	04-05-13	SSP	DWR	RN	RELEASED TO PRODUCTION H. REVISED THE ADJUSTMENT RANGE TOLERANCES G. ADDED '**' SUFFIX TO PANDUIT PART NUMBER F. ADDED NOTE #4 TO GENERAL NOTES E. REMOVED PRIOR NOTE(S)	10D166AH-DC

TITLE						
WYR-GRID 24" WIDTH FIBERRUNNER TRAPEZE BRACKET FOR 4X4 AND 6X4 (WG24FRTB**) 						
CUSTOMER DRAWING						
ITEM REVISION NAME						
10D166AH/03.PRT						
DATASET FILE NAME						
10D166AH_DC/03E WG24FRTB**.PRT						
UNLESS OTHERWISE SPECIFIED, DIMENSIONAL TOLERANCES ARE: IN [mm]						
.X ±		.XXX ±				
.XX ± .05 [1.3]		ANGLES ±				
			THIRD ANGLE PROJECTION			
DRAWN BY		DATE		CHK		SCALE
ERK		06-17-11		DWR		NONE
DRAWING NUMBER:						SIZE
10D166AH-DC						A
SHT 1 OF 1						

D10100DA/11